

EWEZ11

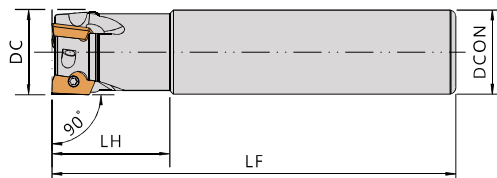

▼Recommended Inserts 建議刀片品牌：SUMITOMO

Standard with Coolant thru

Order No.	Insert	Dimensions(mm)					Screw	Wrench
		刀徑 DC	柄徑 DCON	頭長 LH	長度 LF	刃數 I No.		
Right / Left								
EWEZ11-1416-1TL80H	AOMT11T3 AOET11T3	14	16	25	80	1	CS3006P	FT-8P
EWEZ11-1416-1TL120H		14	16	25	120	1		
EWEZ11-1612-2TL100H		16	12	25	100	2		
EWEZ11-1614-2TL145H		16	14	25	145	2		
EWEZ11-1616-2TL100H		16	16	25	100	2		
EWEZ11-1616-2TL145H		16	16	25	145	2		
EWEZ11-1716-2TL100H		17	16	25	100	2		
EWEZ11-1716-2TL145H		17	16	25	145	2		
EWEZ11-2016-2TL110H		20	16	30	110	2		
EWEZ11-2016-3TL110H		20	16	30	110	3		
EWEZ11-2018-2TL150H		20	18	25	150	2		
EWEZ11-2020-2TL110H		20	20	30	110	2		
EWEZ11-2020-2TL150H		20	20	40	150	2		
EWEZ11-2020-3TL110H		20	20	30	110	3		
EWEZ11-2120-3TL110H		21	20	30	110	3		
EWEZ11-2120-2TL150H		21	20	30	150	2		
EWEZ11-2520-3TL120H		25	20	35	120	3		
EWEZ11-2520-4TL120H		25	20	35	120	4		
EWEZ11-2520-4TL170H		25	20	35	170	4		
EWEZ11-2522-2TL170H		25	22	30	170	2		
EWEZ11-2525-2TL120H		25	25	35	120	2		
EWEZ11-2525-2TL170H		25	25	50	170	2		
EWEZ11-2525-3TL120H		25	25	35	120	3		
EWEZ11-2525-3TL170H		25	25	50	170	3		
EWEZ11-2525-4TL120H		25	25	35	120	4		
EWEZ11-2625-2TL170H		26	25	30	170	2		
EWEZ11-2625-4TL120H		26	25	35	120	4		
EWEZ11-3025-2TL170H		30	25	30	170	2		
EWEZ11-3025-4TL130H	30	25	40	130	4			
EWEZ11-3230-2TL170H	32	30	30	170	2			

EWEZ11-2020-3TL110H with coolant thru 含油孔 / EWEZ11-2020-3TL110 without coolant thru 無油孔

EWEZ11

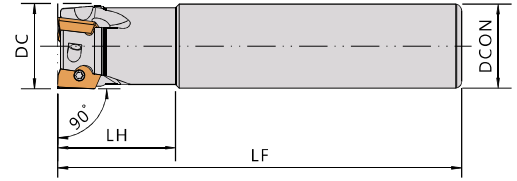

▼Recommended Inserts 建議刀片品牌：SUMITOMO

Standard with Coolant thru

Order No.	Insert	Dimensions(mm)					Screw	Wrench
		刀徑	柄徑	頭長	長度	刃數		
Right / Left		DC	DCON	LH	LF	I No.		
EWEZ11-3225-5TL130H	AOMT11T3 AOET11T3	32	25	40	130	5	CS3006P	FT-8P
EWEZ11-3232-2TL130H		32	32	40	130	2		
EWEZ11-3232-2TL170H		32	32	60	170	2		
EWEZ11-3232-3TL130H		32	32	40	130	3		
EWEZ11-3232-3TL170H		32	32	60	170	3		
EWEZ11-3232-4TL130H		32	32	40	130	4		
EWEZ11-3232-5TL130H		32	32	40	130	5		
EWEZ11-3532-2TL170H		35	32	30	170	2		
EWEZ11-3532-3TL170H		35	32	30	170	3		
EWEZ11-3532-5TL130H		35	32	40	130	5		
EWEZ11-4032-2TL150H		40	32	30	150	2		
EWEZ11-4032-2TL170H		40	32	30	170	2		
EWEZ11-4032-4TL150H		40	32	30	150	4		
EWEZ11-4032-6TL150H		40	32	30	150	6		
EWEZ11-5032-3TL170H		50	32	30	170	3		
EWEZ11-5032-5TL150H		50	32	30	150	5		
EWEZ11-5032-7TL150H		50	32	30	150	7		

EWEZ11-2020-3TL110H with coolant thru 含油孔

EWEZ11-2020-3TL110 without coolant thru 無油孔

FWEZ11 殼型銑刀

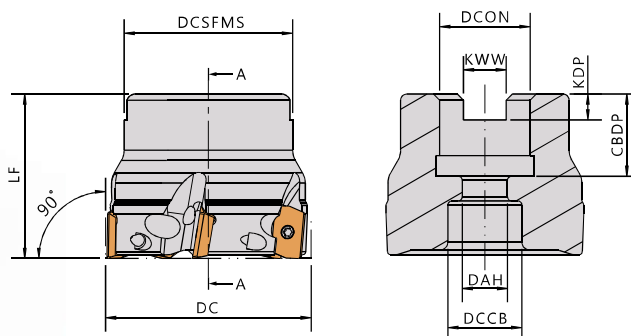

Standard with Coolant thru
 ▼Recommended Inserts 建議刀片品牌: SUMITOMO

Order No.	Insert	Dimensions(mm)						Screw	Wrench
Right / Left		刀徑	長度	孔徑		刃數			
		DC	LF	DCON	DCON(inch)	I No.			
FWEZ11-D40A04H	AOMT11T3 AOET11T3	40	40	16	-	4	CS3006P	FT-8P	
FWEZ11-D50A05H		50	40	22	-	5			
FWEZ11-D63A06H		63	40	22	-	6			
FWEZ11-D80A07H		80	50	27	1"	7			
FWEZ11-D100B09H		100	50/63	32	1-1/4"	9			

FWEZ11-D40A04H with coolant thru 含油孔 / FWEZ11-D40A04 without coolant thru 無油孔

WEZ11 鎖牙式銑刀

Modular End Mill

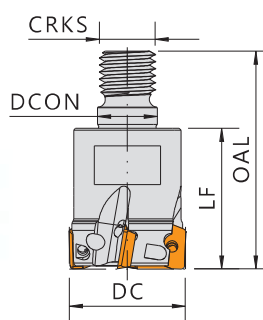

Standard with Coolant thru
 ▼Recommended Inserts 建議刀片品牌: SUMITOMO

Order No.	Insert	Dimensions(mm)						Screw	Wrench
Right / Left		刀徑	柄徑	總長	長度	螺紋	刃數		
		DC	DCON	OAL	LF	CRKS	I No.		
WEZ11013M06Z1H	AOMT11T3 AOET11T3	13	6.5	39.5	25	6	1	CS3006P	FT-8P
WEZ11017M08Z2H		17	8.5	43	25	8	2		
WEZ11021M10Z2H		21	10.5	49	30	10	2		
WEZ11026M12Z3H		26	12.5	57	35	12	3		
WEZ11033M16Z4H		33	17	62	40	16	4		

WEZ11013M06Z1H with coolant thru 含油孔 / WEZ11013M06Z1 without coolant thru 無油孔

EWEZ17

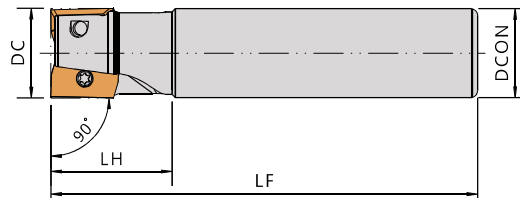

▼Recommended Inserts 建議刀片品牌 : SUMITOMO

Standard with Coolant thru

Order No.	Insert	Dimensions(mm)					Screw	Wrench
		刀徑 DC	柄徑 DCON	頭長 LH	長度 LF	刃數 I No.		
EWEZ17-2520-2TL120H	AOMT1705 AOET1705	25	20	35	120	2	CS4009P	DBIT-TP15
EWEZ17-2525-2TL120H		25	25	35	120	2		
EWEZ17-2525-2TL170H		25	25	50	170	2		
EWEZ17-2825-2TL120H		28	25	35	120	2		
EWEZ17-2825-2TL170H		28	25	50	170	2		
EWEZ17-3025-3TL130H		30	25	40	130	3		
EWEZ17-3025-2TL170H		30	25	50	170	2		
EWEZ17-3225-3TL130H		32	25	40	130	3		
EWEZ17-3230-2TL170H		32	30	50	170	2		
EWEZ17-3232-2TL130H		32	32	40	130	2		
EWEZ17-3232-2TL170H		32	32	60	170	2		
EWEZ17-3232-3TL130H		32	32	40	130	3		
EWEZ17-3232-3TL170H		32	32	60	170	3		
EWEZ17-3532-3TL130H		35	32	40	130	3		
EWEZ17-3532-2TL170H		35	32	50	170	2		
EWEZ17-4032-2TL170H		40	32	50	170	2		
EWEZ17-4032-3TL135H		40	32	30	135	3		
EWEZ17-4032-3TL170H		40	32	50	170	3		
EWEZ17-4032-4TL135H		40	32	30	135	4		
EWEZ17-4032-4TL170H		40	32	50	170	4		

EWEZ17-2520-2TL120H with coolant thru 含油孔

EWEZ17-2520-2TL120 without coolant thru 無油孔

EWEZ17

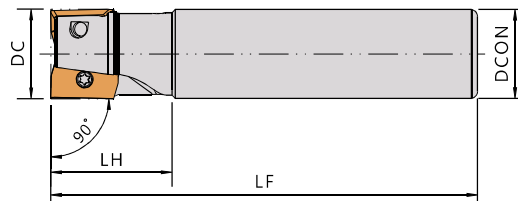

▼Recommended Inserts 建議刀片品牌：SUMITOMO

Standard with Coolant thru

Order No.	Insert	Dimensions(mm)					Screw	Wrench
		刀徑	柄徑	頭長	長度	刃數		
Right / Left		DC	DCON	LH	LF	I No.		
EWEZ17-5032-3TL135H	AOMT1705 AOET1705	50	32	30	135	3	CS4009P	DBIT-TP15
EWEZ17-5032-3TL170H		50	32	50	170	3		
EWEZ17-5032-5TL135H		50	32	30	135	5		
EWEZ17-5032-5TL170H		50	32	50	170	5		
EWEZ17-5042-3TL135H		50	42	30	135	3		
EWEZ17-5042-3TL170H		50	42	50	170	3		
EWEZ17-5042-5TL135H		50	42	30	135	5		
EWEZ17-5042-5TL170H		50	42	50	170	5		
EWEZ17-6332-4TL135H		63	32	30	135	4		
EWEZ17-6332-4TL170H		63	32	50	170	4		
EWEZ17-6332-6TL135H		63	32	30	135	6		
EWEZ17-6332-6TL170H		63	32	50	170	6		
EWEZ17-6342-4TL135H		63	42	30	135	4		
EWEZ17-6342-4TL170H		63	42	50	170	4		
EWEZ17-6342-6TL135H		63	42	30	135	6		
EWEZ17-6342-6TL170H		63	42	50	170	6		
EWEZ17-8032-7TL135H	80	32	30	135	7			

EWEZ17-2520-2TL120H with coolant thru 含油孔

EWEZ17-2520-2TL120 without coolant thru 無油孔

FWEZ17 殼型銑刀

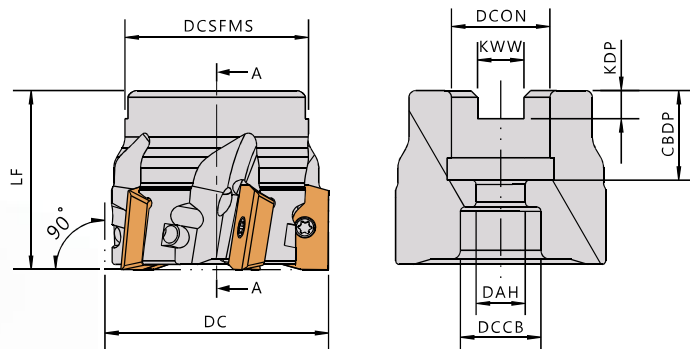
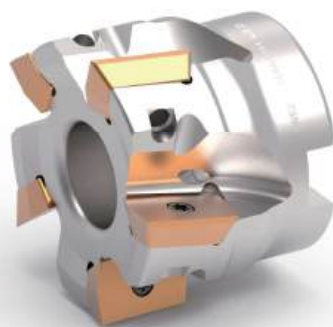

▼Recommended Inserts 建議刀片品牌：SUMITOMO

Standard with Coolant thru

Order No.	Insert	Dimensions(mm)							Screw	Wrench
		刀徑	長度	孔徑		刃數				
Right / Left		DC	LF	DCON	DCON(inch)	I No.				
FWEZ17-D40A03H	AOMT1705 AOET1705	40	40	16	-	3	4	-	CS4009P	DBIT-TP15
FWEZ17-D50A03H		50	40	22	-	3	5	-		
FWEZ17-D63A04H		63	40	22	-	4	6	-		
FWEZ17-D80A04H		80	50	27	1"	4	7	-		
FWEZ17-D100B05H		100	50/63	32	1-1/4"	5	8	-		
FWEZ17-D125A06H		125	63	40	1-1/2"	6	9	11		
FWEZ17-D160C08H		160	63	40	2"	8	10	12		

FWEZ17-D40A03H with coolant thru 含油孔

FWEZ17-D40A03 without coolant thru 無油孔

APX30 直角端銑刀

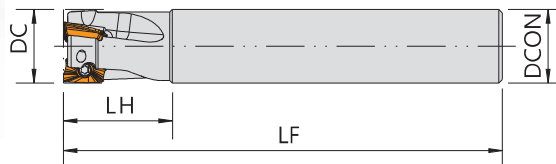
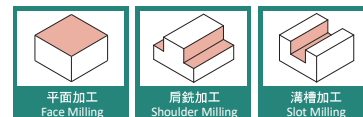

▼Recommended Inserts 建議刀片品牌：MITSUBISHI

Order No.	Insert	Dimensions(mm)					Screw	Wrench
Right / Left		刀徑 DC	柄徑 DCON	頭長 LH	長度 LF	刃數 I No.		
APX30162S16-100	AOMT1236 AOGT1236	16	16	25	100	2	CS25055 / CS25052S	DT-8
APX30172S16-150		17	16	25	150	2		
APX30203S20-100		20	20	30	100	3	CS25062S	
APX30212S20-150		21	20	30	150	2		
APX30253S25-120		25	25	35	120	3		
APX30324S32-150		32	32	45	150	4		

BAP30 BAP40 直角端銑刀

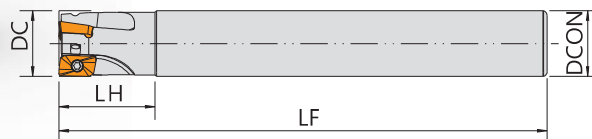
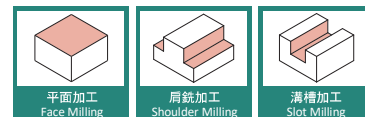

▼Recommended Inserts 建議刀片品牌：MITSUBISHI/ACC

Order No.	Insert	Dimensions(mm)					Screw	Wrench
Right / Left		刀徑	長度	頭長	柄徑	刃數		
		DC	LF	LH	DCON	I No.		
BAP30121S16-100	APGT1135 APMT1135	12	100	25	16	1	CS25055 / CS25052S	DT-8
BAP30162S16-100		16	100	25	16	2		
BAP30162S16-150		16	150	25	16	2		
BAP30162S16-160		16	160	25	16	2		
BAP30172S16-150		17	150	25	16	2		
BAP30182S16-150		18	150	25	16	2		
BAP30202S20-150		20	150	30	20	2	CS25062S	
BAP30203S20-100		20	100	30	20	3		
BAP30212S20-150		21	150	30	20	2		
BAP30223S20-100		22	100	30	20	3		
BAP30253S25-200		25	200	35	25	3		
BAP30254S25-120		25	120	35	25	4		
BAP30254S25-150		25	150	35	25	4		
BAP30263S25-200		26	200	35	25	3		
BAP30323S32-200		32	200	45	32	3		
BAP30325S32-150		32	150	45	32	5		
BAP30334S32-200	33	200	45	32	4			
BAP40252S25-115	APGT1604 APMT1604	25	115	35	25	2	CS40090	DBIT-T15
BAP40323S32-125		32	125	45	32	3		
BAP40404S32-125		40	125	45	32	4		

BAP3 BAP4 直角殼型銑刀

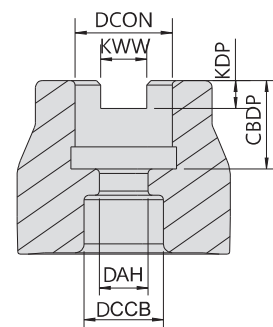
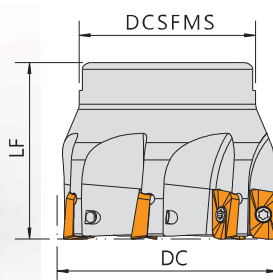
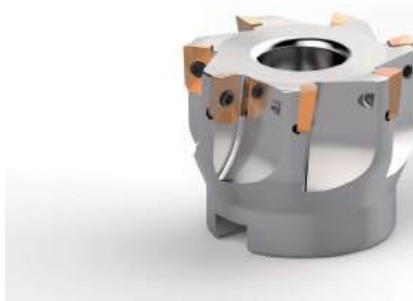
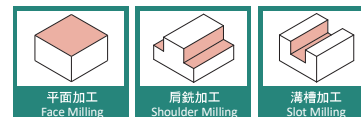

▼Recommended Inserts 建議刀片品牌：MITSUBISHI/ACC

Standard with Coolant thru

Order No.	Insert	Dimensions(mm)					Screw	Wrench
		刀徑	長度	孔徑		刃數		
Right / Left		DC	LF	DCON	DCON (inch)	I No.		
BAP3-05007R	APGT1135 APMT1135	50	40	22	-	7	CS25062S	FT-8
BAP3-06308R		63	40	22	1"	8		
BAP3-08009R		80	50	27	1"	9		
BAP4-05005R	APGT1604 APMT1604	50	40	22	-	5	CS40090	DBIT-T15
BAP4-06306R		63	40	22	1"	6		
BAP4-08007R		80	50	27	1"	7		
BAP4-10008R		100	50	32	1-1/4"	8		
BAP4-12509R		125	50	40	1-1/2"	9		

▼Inserts 刀片：

●=Stock / ◎=1st Choice 首選 / ○=2nd Choice 次選 / X=Not Recommend 不建議

Tolerance Class 精度	P	鋼 Carbon Steels	◎	◎				
	M	不鏽鋼 Stainless Steels	◎	◎				
M級	K	鑄鐵 Cast Iron	◎	◎				
Specification 規格		Grade 材質		Dimensions(mm) 尺寸				
		VS203	VP15TF	L	W	T	d	r
APMT113504PDER		●	●	11	6.35	3.5	2.8	0.4
APMT113508PDER		●	●	11	6.35	3.5	2.8	0.8
APMT160408PDER		●	●	16.5	9.525	4.76	4.5	0.8

BAP300 BAP400 鎖牙式銑刀

Modular End Mill

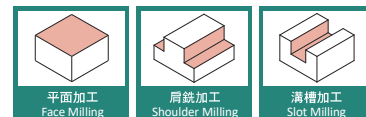
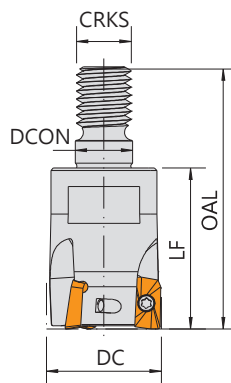

▼Recommended Inserts 建議刀片品牌：MITSUBISHI/ACC

Order No.	Insert	Dimensions(mm)						Screw	Wrench
		刀徑 DC	柄徑 DCON	全總長 OAL	長度 LF	螺紋 CRKS	刃數 I No.		
BAP300R111-M05	APGT1135 APMT1135	11	5.5	33.5	21	M5	1	CS25055 / CS25052S	FT-8
BAP300R131-M06		13	6.5	37.5	23	M6	1		
BAP300R162-M08		16	8.5	43	25	M8	2		
BAP300R172-M08		17					2		
BAP300R202-M10		20	10.5	51	32	M10	2	CS25062S	
BAP300R203-M10		20					3		
BAP300R212-M10		21					2		
BAP300R253-M12		25	12.5	57	35	M12	3		
BAP300R263-M12		26					3		
BAP300R324-M16		32					4		
BAP300R334-M16		33	17	65	43	M16	4	CS40090	
BAP300R354-M16		35					4		
BAP400R252-M12	APGT1604 APMT1604	25	12.5	60	38	M12	2		FT-15
BAP400R262-M12		26					2		
BAP400R322-M16		32	17	65	43	M16	2		
BAP400R332-M16		33					2		
BAP400R352-M16		35					2		

E90AP10

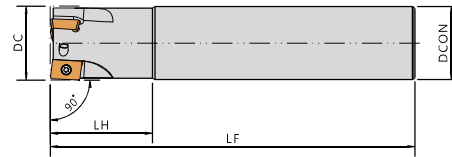
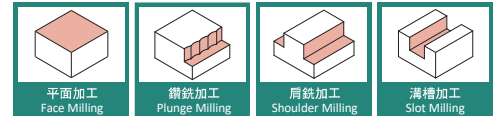

▼Recommended Inserts 建議刀片品牌：SUMITOMO/NACHI

Order No.	Insert	Dimensions(mm)					Screw	Wrench
		刀徑	長度	頭長	柄徑	刃數		
Right / Left		DC	LF	LH	DCON	I No.		
E90AP10-D10F01	APMT1035PDER	10	80	20	10	1	CS25045	DT-8
E90AP10-D10K01		10	120	30	10	1		
E90AP10-D10M01		10	150	30	10	1		
E90AP10-D10F01-12		10	80	20	12	1		
E90AP10-D12F01	APMT1035PDER	12	80	17	12	1	CS25055 / CS25052S	
E90AP10-D12M01		12	150	25	12	1		
E90AP10-D13F01		12	80	17	12	1		
E90AP10-D14G01		14	90	25	16	1		
E90AP10-D16G02	APMT1035PDER	16	90	25	16	2	CS25062S	
E90AP10-D16L02		16	140	25	16	2		
E90AP10-D16M02		16	150	25	16	2		
E90AP10-D16R02		16	200	25	16	2		
E90AP10-D18G02		18	90	25	16	2		
E90AP10-D20J02		20	110	30	20	2		
E90AP10-D20M02		20	150	30	20	2		
E90AP10-D20R02		20	200	30	20	2		
E90AP10-D21M03		21	150	30	20	3		
E90AP10-D25K03		25	120	35	25	3		
E90AP10-D25N03		25	160	35	25	3		
E90AP10-D25R03		25	200	35	25	3		
E90AP10-D30K04		30	120	35	32	4		
E90AP10-D32Q04		32	180	35	32	4		

多刃型 FINE PITCH								
Order No.	Insert	刀徑	長度	頭長	柄徑	刃數	Screw	Wrench
E90AP10-D20J03	APMT1035PDER	20	110	30	20	3	CS25062S	DT-8
E90AP10-D20M03		20	150	30	20	3		
E90AP10-D25K04		25	120	35	25	4		
E90AP10-D25N04		25	160	60	25	4		
E90AP10-D26N04		26	160	35	25	4		
E90AP10-D32K05		32	120	35	32	5		
E90AP10-D32Q05		32	180	80	32	5		
E90AP10-D33Q05		33	180	35	32	5		
E90AP10-D40K06		40	125	40	32	6		
E90AP10-D40R06		40	200	100	32	6		

E90AP16

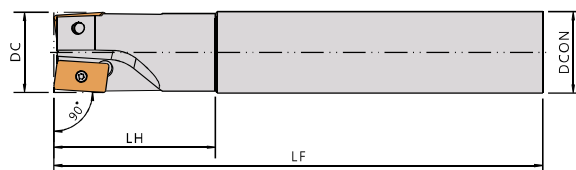
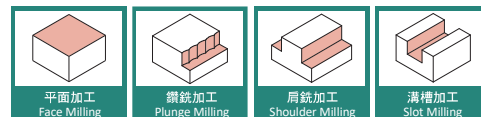

▼ Recommended Inserts 建議刀片品牌：SUMITOMO/NACHI

Order No.	Insert	Dimensions(mm)					Screw	Wrench
		刀徑 DC	長度 LF	頭長 LH	柄徑 DCON	刃數 I No.		
Right / Left								
E90AP16-D25K02	APMT1605PDER	25	125	35	25	2	CS35090	DBIT-T15
E90AP16-D25N02		25	160	35	25	2		
E90AP16-D25R02		25	200	35	25	2		
E90AP16-D25S02		25	250	35	25	2		
E90AP16-D26N02		26	160	35	25	2		
E90AP16-D32K03		32	125	40	32	3		
E90AP16-D32Q03		32	180	60	32	3		
E90AP16-D35K03		35	125	40	32	3		
E90AP16-D40K04		40	125	45	32	4		
E90AP16-D40M04		40	150	45	32	4		
E90AP16-D40R04		40	200	45	32	4		
E90AP16-D50K05		50	125	40	32	5		
E90AP16-D63K06		63	125	40	32	6		

EM90AP

粗銑刀

Helical End Mill

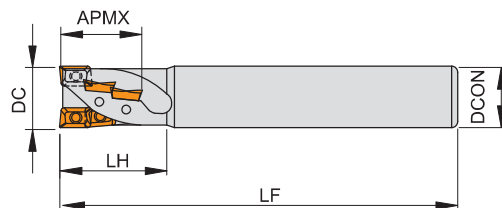
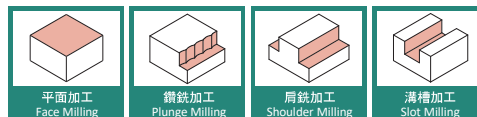

▼Recommended Inserts 建議刀片品牌：SUMITOMO/NACHI

Order No.	Insert	Dimensions(mm)							Screw	Wrench
		刀徑	長度	頭長	柄徑	切削刃長	有效刃數	刃數		
Right / Left		DC	LF	LH	DCON	APMX	T No.	I No.		
EM90AP10-D20K06	APMT1035PDER	20	125	35	20	23	2	6	CS25062S	DT-8
EM90AP10-D25K08		25	125	45	25	36	2	8		
EM90AP10-D32L15		32	140	55	32	44	3	15		
EM90AP10-D40M18		40	150	65	32	54	3	18		
EM90AP10-D40M21		40	150	73	32	62	3	21		
EM90AP16-D40M12	APMT1605PDER	40	150	65	42	51	3	12	CS35090	DBIT-T15
EM90AP16-D40R21		40	200	99	42	80	3	21		
EM90AP16-D50N15		50	165	75	42	59	3	15		

DM90AP

鑽銑刀

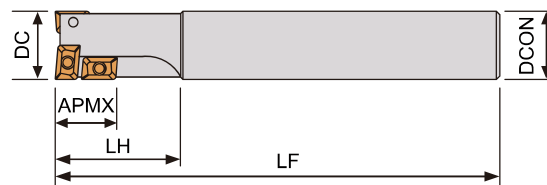

▼Recommended Inserts 建議刀片品牌：SUMITOMO/NACHI

Order No.	Insert	Dimensions(mm)						Screw	Wrench
		刀徑	長度	切削刃長	柄徑	頭長	刃數		
Right / Left		DC	LF	APMX	DCON	LH	I No.		
DM90AP10-D20K03	APMT1035PDER	20	125	16	20	35	3	CS25062S	DT-8
DM90AP10-D20Q03		20	185	16	20	35	3		
DM90AP10-D21K03		21	125	16	20	35	3		
DM90AP10-D25L04		25	140	24	25	35	4		
DM90AP10-D25R04		25	220	24	25	35	4		
DM90AP10-D26L04		26	140	24	25	35	4		
DM90AP10-D30M05		30	150	32	25	50	5		
DM90AP16-D32M04	APMT1605PDER	32	150	40	32	50	4	CS35090	DBIT-T15
DM90AP16-D32S04		32	250	40	32	60	4		
DM90AP16-D33M04		33	150	40	32	50	4		
DM90AP16-D40N04		40	160	40	32	60	4		
DM90AP16-D40S04		40	250	40	32	60	4		

MSAP10

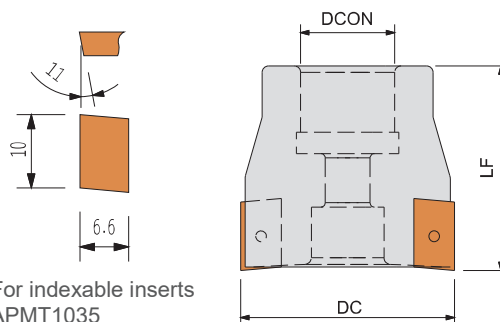
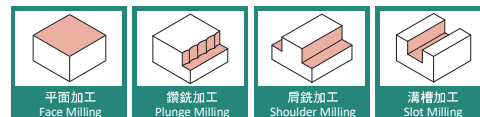

For indexable inserts
APMT1035

▼Recommended Inserts 建議刀片品牌：SUMITOMO/NACHI

Order No.	Insert	Dimensions(mm)					Screw	Wrench
		刀徑 DC	長度 LF	孔徑 DCON		刃數 I No.		
MSAP10-D040A06R	APMT1035PDER	40	40	16	-	6	CS25062S	FT-8
MSAP10-D050A07R		50	40	22	-	7		
MSAP10-D063A09R		63	46	22	1"	9		
MSAP10-D080A11R		80	46	27	1"	11		

MSAP16

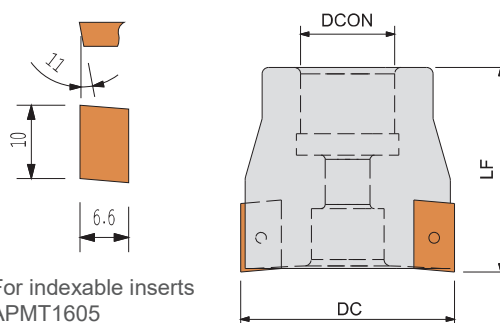
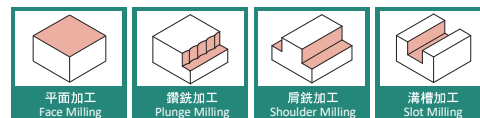

For indexable inserts
APMT1605

▼Recommended Inserts 建議刀片品牌：SUMITOMO/NACHI

Order No.	Insert	Dimensions(mm)					Screw	Wrench
		刀徑 DC	長度 LF	孔徑 DCON		刃數 I No.		
MSAP16-D040A03R	APMT1605PDER	40	40	16	-	3	CS35090	DBIT-T15
MSAP16-D050A05R		50	40	22	-	5		
MSAP16-D063A06R		63	46	22	1"	6		
MSAP16-D080B08R		80	46	27	1"	8		
MSAP16-D100B10R		100	50	32	1-1/4"	10		

E90APK10

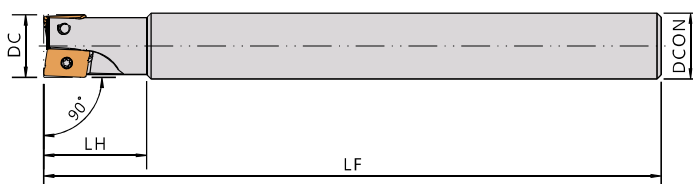
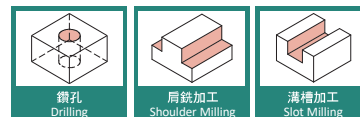

▼Recommended Inserts 建議刀片品牌：CERATIZIT

Order No.	Insert	Dimensions(mm)					Screw	Wrench
		刀徑 DC	長度 LF	頭長 LH	柄徑 DCON	刃數 I No.		
E90APK10-D10F01-12	APKT1003	10	80	20	12	1	CS25045	DT-8
E90APK10-D10K01-12		10	125	20	12	1		
E90APK10-D10M01-12		10	150	20	12	1		
E90APK10-D12F01	APKT1003	12	80	25	12	1	CS25055 / CS25052S	
E90APK10-D12M01		12	150	25	12	1		
E90APK10-D16G02		16	90	25	16	2		
E90APK10-D16M02		16	150	25	16	2		
E90APK10-D16R02	APKT1003	16	200	25	16	2	CS25062S	
E90APK10-D20J02		20	110	25	20	2		
E90APK10-D20M02		20	150	25	20	2		
E90APK10-D20R02		20	200	25	20	2		
E90APK10-D25M03		25	150	30	25	3		
E90APK10-D25R03	25	200	30	25	3			

E90APK16

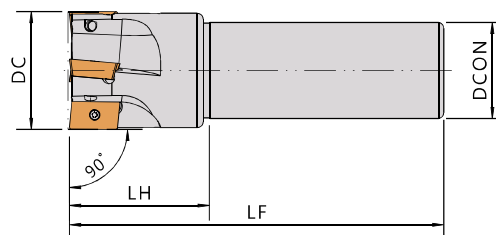
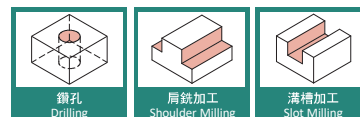

▼Recommended Inserts 建議刀片品牌：CERATIZIT

Order No.	Insert	Dimensions(mm)					Screw	Wrench
		刀徑 DC	長度 LF	頭長 LH	柄徑 DCON	刃數 I No.		
E90APK16-D25M02	APKT1604	25	150	30	25	2	CS35090	DBIT-T15
E90APK16-D25R02		25	200	30	25	2		
E90APK16-D32Q03		32	180	40	32	3		
E90APK16-D40R04		40	200	45	32	4		

E90AX12 E90AX12-L

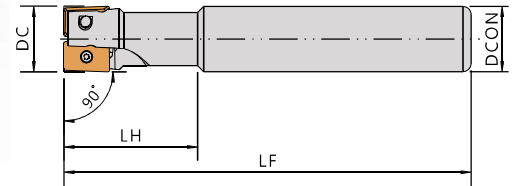
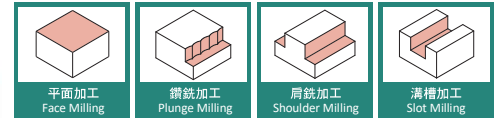

▼Recommended Inserts 建議刀片品牌：SUMITOMO/NACHI

Order No.	Insert	Dimensions(mm)					Screw	Wrench
		刀徑 DC	長度 LF	頭長 LH	柄徑 DCON	刃數 I No.		
E90AX12-D14	AXMT1235	14	80	25	16	1	CS30053	DT-8
E90AX12-D14-160		14	160	25	16	1		
E90AX12-D15		15	100	25	16	2		
E90AX12-D16		16	100	25	16	2		
E90AX12-D16-150		16	150	25	16	2		
E90AX12-D16-200		16	200	25	16	2		
E90AX12-D17-150		17	150	25	16	2		
E90AX12-D17-200		17	200	25	16	2		
E90AX12-D18		18	100	25	16	2		
E90AX12-D20-02		20	110	30	20	2		
E90AX12-D20		20	110	30	20	3		
E90AX12-D20-150		20	150	30	20	3		
E90AX12-D20-200		20	200	30	20	3		
E90AX12-D21-150		21	150	30	20	3		
E90AX12-D21-200		21	200	30	20	3		
E90AX12-D22		22	110	30	20	3		
E90AX12-D22-150		22	150	30	20	3		
E90AX12-D22-200		22	200	30	20	3		
E90AX12-D25-03		25	120	35	25	3		
E90AX12-D25		25	120	35	25	4		
E90AX12-D25-150		25	150	35	25	4		
E90AX12-D25-200		25	200	35	25	4		
E90AX12-D26-150		26	150	35	25	4		
E90AX12-D26-200		26	200	35	25	4		
E90AX12-D28		28	120	35	25	4		
E90AX12-D30		30	120	35	25	4		
E90AX12-D32		32	130	40	32	5		
E90AX12-D33-200		33	200	40	32	5		
E90AX12-D40	40	150	30	32	6			

E90AX12-D16H with coolant thru 含油孔 / E90AX12-D16 without coolant thru 無油孔
E90AX12-D16LH with longer shank and coolant thru 加長型含油孔

E90AX12-H E90AX12-LH

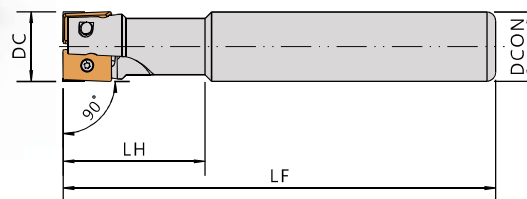
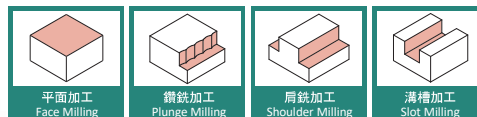

▼Recommended Inserts 建議刀片品牌：SUMITOMO/NACHI

Order No. Right / Left	Insert 	Dimensions(mm)					Screw 	Wrench
		刀徑 DC	長度 LF	頭長 LH	柄徑 DCON	刃數 I No.		
E90AX12-D14H	AXMT1235	14	80	25	16	1	CS30053	DT-8
E90AX12-D16H		16	100	25	16	2		
E90AX12-D18H		18	100	25	16	2		
E90AX12-D20H		20	110	30	20	3	CS30063	
E90AX12-D22H		22	110	30	20	3		
E90AX12-D25H		25	120	35	25	4		
E90AX12-D28H		28	120	35	25	4		
E90AX12-D30H		30	120	35	25	4		
E90AX12-D32H		32	130	40	32	5		
E90AX12-D40H		40	150	30	32	6		

Order No. Right / Left	Insert 	Dimensions(mm)					Screw 	Wrench
		刀徑 DC	長度 LF	頭長 LH	柄徑 DCON	刃數 I No.		
E90AX12-D14LH	AXMT1235	14	120	25	16	1	CS30053	DT-8
E90AX12-D16LH		16	145	25	16	2		
E90AX12-D18LH		18	145	25	16	2		
E90AX12-D20LH		20	150	40	20	2	CS30063	
E90AX12-D20LH-03		20	150	40	20	3		
E90AX12-D21LH-03		21	150	40	20	3		
E90AX12-D22LH		22	150	30	20	2		
E90AX12-D25LH		25	170	50	25	2		
E90AX12-D25LH-04		25	170	50	25	4		
E90AX12-D28LH		28	170	30	25	2		
E90AX12-D30LH		30	170	30	25	2		
E90AX12-D32LH		32	180	60	32	2		
E90AX12-D40LH		40	180	30	32	2		

E90AX12-D16H with coolant thru 含油孔 / E90AX12-D16 without coolant thru 無油孔

E90AX12-D16LH with longer shank and coolant thru 加長型含油孔

E90AX17-H E90AX17-LH

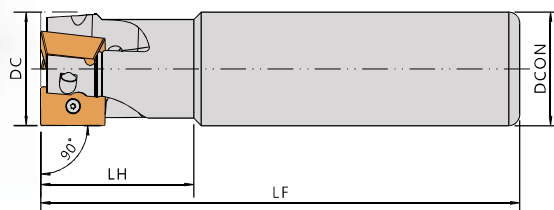
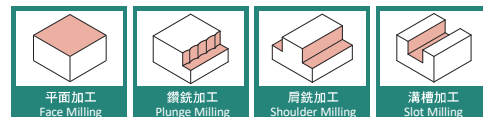

▼Recommended Inserts 建議刀片品牌：SUMITOMO/NACHI

Order No.	Insert	Dimensions(mm)					Screw	Wrench
Right / Left		刀徑	長度	頭長	柄徑	刃數		
		DC	LF	LH	DCON	I No.		
E90AX17-D25H	AXMT1705	25	120	35	25	2	CS4009P	DBIT-TP15
E90AX17-D25H-20		25	120	35	20	2		
E90AX17-D28H		28	120	35	25	2		
E90AX17-D30H		30	130	40	25	3		
E90AX17-D30H-32		30	130	40	32	3		
E90AX17-D32H		32	130	40	32	3		
E90AX17-D32H-02		32	130	40	32	2		
E90AX17-D32H-25		32	130	40	25	3		
E90AX17-D35H		35	130	40	32	3		
E90AX17-D40H		40	170	50	32	4		
E90AX17-D50H		50	170	50	32	5		
E90AX17-D63H		63	170	50	32	6		
E90AX17-D63H-04		63	170	50	32	4		

Order No.	Insert	Dimensions(mm)					Screw	Wrench
Right / Left		刀徑	長度	頭長	柄徑	刃數		
		DC	LF	LH	DCON	I No.		
E90AX17-D25LH	AXMT1705	25	170	50	25	2	CS4009P	DBIT-TP15
E90AX17-D28LH		28	170	50	25	2		
E90AX17-D30LH		30	180	60	25	2		
E90AX17-D32LH		32	180	60	32	2		
E90AX17-D32LH-03		32	180	60	32	3		
E90AX17-D35LH		35	180	60	32	2		
E90AX17-D40LH		40	220	80	32	2		

E90AX17-D25H with coolant thru 含油孔 / E90AX17-D25 without coolant thru 無油孔

E90AX17-D25LH with longer shank and coolant thru 加長型含油孔

E90AX06

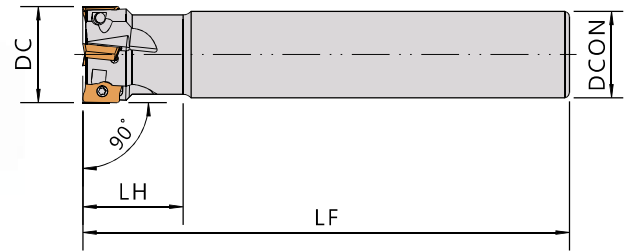
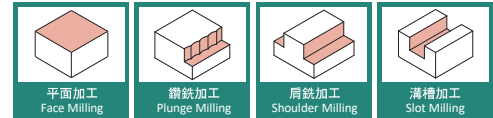

▼Recommended Inserts 建議刀片品牌：SUMITOMO

Order No.	Insert	Dimensions(mm)					Screw	Wrench
Right / Left		刀徑	長度	頭長	柄徑	刃數		
		DC	LF	LH	DCON	I No.		
E90AX06-D10	AXMT0602	10	80	15	10	2	CS18040	FT-6
E90AX06-D12		12	80	20	12	3		
E90AX06-D14		14	80	20	12	3		
E90AX06-D16		16	90	20	16	4		
E90AX06-D18		18	90	20	16	4		
E90AX06-D20		20	100	25	20	5		
E90AX06-D10-L130	AXMT0602	10	130	15	10	2	CS18040	FT-6
E90AX06-D11-L150		11	150	15	10	2		
E90AX06-D12-L130		12	130	20	12	3		
E90AX06-D13-L150		13	150	20	12	3		
E90AX06-D16-L150		16	150	20	16	4		
E90AX06-D17-L150		17	150	20	16	4		

E90AX06-D16 without coolant thru 無油孔

E90AX06-D16H with coolant thru 含油孔

E90AX06-D16LH with longer shank and coolant thru 加長型含油孔

EM90AX

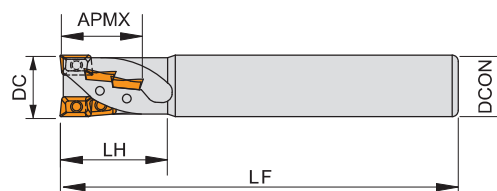
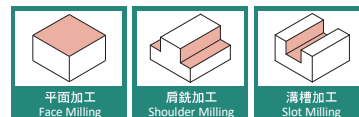

▼Recommended Inserts 建議刀片品牌：SUMITOMO/NACHI

Order No.	Insert	Dimensions(mm)							Screw	Wrench
		刀徑	長度	頭長	柄徑	切削刃長	有效刃數	刃數		
Right / Left		DC	LF	LH	DCON	APMX	T No.	I No.		
EM90AX12-D20X	AXMT1235	20	130	45	20	27	2	6	CS30063	DT-8
EM90AX12-D25		25	130	45	25	27	2	6		
EM90AX12-D32		32	130	45	32	27	3	9		
EM90AX12-D40		40	130	45	32	36	4	16		
EM90AX12-D20L	AXMT1235	20	130	45	20	36	1	4	CS30063	DT-8
EM90AX12-D20LX		20	130	45	20	36	2	8		
EM90AX12-D25L		25	130	45	25	36	2	8		
EM90AX12-D32L		32	150	65	32	45	3	15		

Order No.	Insert	Dimensions(mm)							Screw	Wrench
		刀徑	長度	頭長	柄徑	切削刃長	有效刃數	刃數		
Right / Left		DC	LF	LH	DCON	APMX	T No.	I No.		
EM90AX17-D32	AXMT1705	32	150	65	32	40	2	6	CS4009P	DBIT-TP15
EM90AX17-D40		40	150	65	42	40	3	9		
EM90AX17-D50		50	165	75	42	53	3	12		

EM90AX-S

殼型銑刀

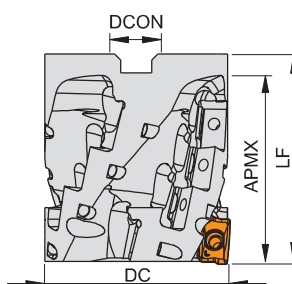

▼Recommended Inserts 建議刀片品牌：SUMITOMO/NACHI

Order No.	Insert	Dimensions(mm)							Screw	Wrench
		刀徑	孔徑		切削刃長	長度	有效刃數	刃數		
Right / Left		DC	DCON	DCON(inch)	APMX	LF	T No.	I No.		
EM90AX17-D50S	AXMT1705	50	22	-	53	70	3	12	CS4009P	DBIT-TP15
EM90AX17-D63S		63	27	1"	53	70	4	16		
EM90AX17-D63SL		63	27	1"	68	98	4	20		
EM90AX17-D75SL		75	-	1-1/4"	80	111	4	24		
EM90AX17-D80S		80	32	1-1/4"	53	85	5	20		
EM90AX17-D100S		100	40	-	53	85	6	24		

MSAX 殼型銑刀

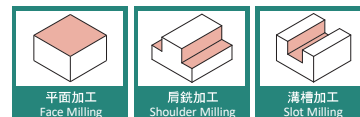
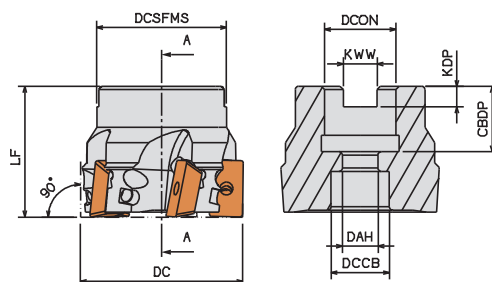

▼Recommended Inserts 建議刀片品牌：SUMITOMO/NACHI

Order No.	Insert	Dimensions(mm)				Screw	Wrench
Right / Left		刀徑	長度	孔徑			
		DC	LF	DCON	DCON(inch)		
MSAX12-D040A06	AXMT1235	40	40	16	-	CS30063	FT-8
MSAX12-D050A07		50	40	22	-		
MSAX12-D063A08		63	40	22	1"		

MSAX12-D040A06H x16 with coolant thru 含油孔

▼Standard Pitch Type

Order No.	Insert	Dimensions(mm)				Screw	Wrench
Right / Left		刀徑	長度	孔徑			
		DC	LF	DCON	DCON(inch)		
MSAX17-D040A04	AXMT1705	40	40	16	-	CS4009P	DBIT-TP15
MSAX17-D050A05		50	40	22	-		
MSAX17-D063A06		63	50	22	1"		
MSAX17-D080A07		80	50	27	1"		
MSAX17-D100B08		100	63	32	1-1/4"		
MSAX17-D125B09		125	63	40	1-1/2"		

MSAX17-D040A06H x16 with coolant thru 含油孔

M75AX 殼型銑刀

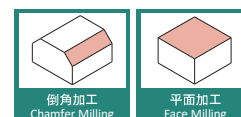
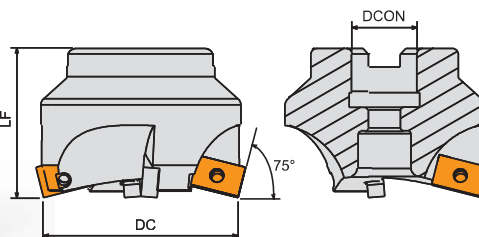

▼Recommended Inserts 建議刀片品牌：SUMITOMO/NACHI

Order No.	Insert	Dimensions(mm)				Screw	Wrench
Right / Left		刀徑	長度	孔徑	刃數		
		DC	LF	DCON	I No.		
M75AX17-D063A04 x22	AXMT1705	63	50	22	4	CS4009P	DBIT-TP15
M75AX17-D080B05 x27		80	50	27	5		
M75AX17-D100B06 x32		100	63	32	6		
M75AX17-D125B07 x40		125	63	40	7		

TEBL

高進給端銑刀

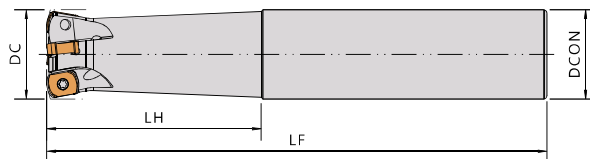

▼Recommended Inserts 建議刀片品牌: Taegutec

Standard with Coolant thru

Order No.	Insert	Dimensions(mm)					Insert Screw	Wrench
		刀徑	孔徑	頭長	長度	刃數		
TEBL216-16-06-L120H	BLMP0603R	16	16	40	120	2	CS2508PS	FT-8P
TEBL320-20-06-L130H		20	20	50	130	3		
TEBL425-25-06-L140H		25	25	60	140	4		
TEBL532-32-06-L150H		32	32	70	150	5		

TEBL

鎖牙式銑刀

Modular End Mill

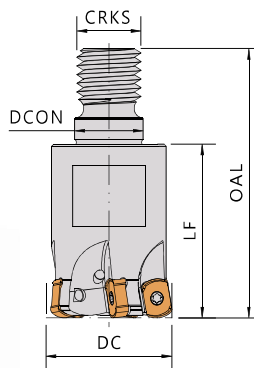
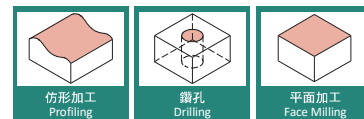

▼Recommended Inserts 建議刀片品牌: Taegutec

Standard with Coolant thru

Order No.	Insert	Dimensions(mm)						Insert Screw	Wrench
		刀徑	柄徑	總長	長度	螺紋	刃數		
TEBL216-M08-06H	BLMP0603R	16	8.5	43	25	8	2	CS2508PS	FT-8P
TEBL320-M10-06H		20	10.5	49	30	10	3		
TEBL425-M12-06H		25	12.5	57	35	12	4		
TEBL532-M16-06H		32	17	62	40	16	5		
TEBL535-M16-06H		35	17	62	40	16	5		
TEBL640-M16-06H		40	17	62	40	16	6		
TEBL642-M16-06H		42	17	62	40	16	6		

ETD

圓角端銑刀

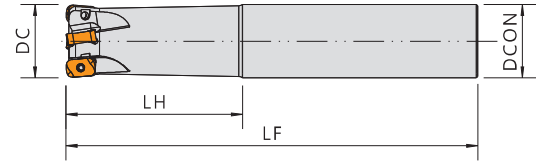
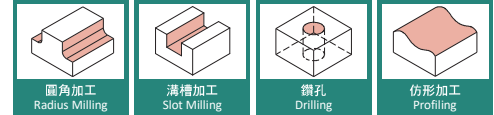

▼Recommended Inserts 建議刀片品牌：HITACHI

Order No.	Insert	Dimensions(mm)					Screw	Wrench
		刀徑 DC	柄徑 DCON	長度 LF	頭長 LH	刃數 I No.		
ETD4N1616-2TL100	ENMU0603ER-C ENMU0603ER-B	16	16	100	30	2	CS25062S	FT-8
ETD4N1616-2TL-150		16	16	150	50	2		
ETD4N1716-2TL-150		17	16	150	30	2		
ETD4N2020-3TL130		20	20	130	50	3		
ETD4N2020-3TL160		20	20	160	80	3		
ETD4N2120-3TL-150		21	20	150	30	3		
ETD4N2525-4TL140		25	25	140	60	4		
ETD4N2525-4TL180		25	25	180	100	4		
ETD4N2625-4TL-150		26	25	150	35	4		
ETD4N3232-5TL-150		32	32	150	70	5		
ETD4N3232-5TL-200		32	32	200	120	5		
ETD4N3532-5TL-150		35	32	150	35	5		
ETD4N4032-6TL220		40	32	220	45	6		

HTD

鎖牙式銑刀

Modular End Mill

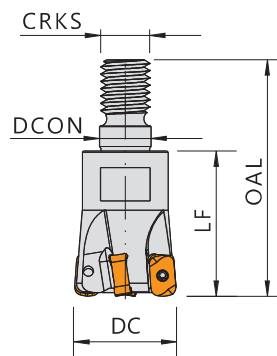
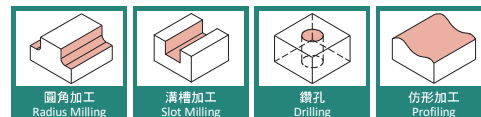

▼Recommended Inserts 建議刀片品牌：HITACHI

Order No.	Insert	Dimensions(mm)						Screw	Wrench
		刀徑	柄徑	總長	長度	螺紋	刃數		
Right / Left		DC	DCON	OAL	LF	CRKS	I No.		
HTD4N16M08-2T	ENMU0603ER-C ENMU0603ER-B	16	8.5	43	25	M08	2	CS25062S	FT-8
HTD4N17M08-2T		17	8.5	43	25	M08	2		
HTD4N20M10-3T		20	10.5	49	30	M10	3		
HTD4N21M10-3T		21	10.5	49	30	M10	3		
HTD4N25M12-4T		25	12.5	57	35	M12	4		
HTD4N25M12-4T		25	12.5	57	35	M12	4		
HTD4N26M12-4T		26	12.5	57	35	M16	4		
HTD4N32M16-5T		32	17	62	40	M16	5		
HTD4N35M16-5T		35	17	62	40	M16	5		

MXG

鎖牙式銑刀

Modular End Mill

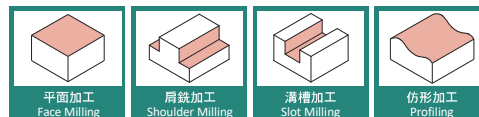
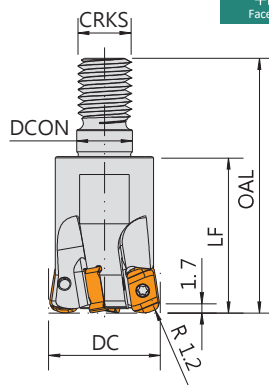

▼Recommended Inserts 建議刀片品牌：DIJET

Double sided insert with 4 cutting edges

Without Coolant thru 無油孔									
Order No.	Insert	Dimensions(mm)						Screw	Wrench
		刀徑 DC	柄徑 DCON	總長 OAL	長度 LF	螺紋 CRKS	刃數 I No.		
MXG2016-M8	ENMU100412	16	5.5	42	25	M8	2	CS25055 / CS25052S	FT-8
MXG2017-M8		17	5.5	42	25	M8	2		
MXG2018-M8		18	5.5	42	25	M8	2		
MXG3020-M10		20	5.5	42	30	M10	3	CS25062S	
MXG3022-M10		22	5.5	49	30	M10	3		
MXG4025-M12		25	5.5	49	35	M12	4		
MXG4028-M12		28	5.5	57	35	M12	4		

With Coolant thru 含油孔									
Order No.	Insert	Dimensions(mm)						Screw	Wrench
		刀徑 DC	柄徑 DCON	總長 OAL	長度 LF	螺紋 CRKS	刃數 I No.		
MXG2016H-M8	ENMU100412	16	5.5	42	25	M8	2	CS25055 / CS25052S	FT-8
MXG3020H-M10		20	5.5	42	30	M10	3		
MXG4025H-M12		25	5.5	49	35	M12	4		
MXG5032H-M16		32	6	57	40	M16	5	CS25062S	
MXG5035H-M16		35	6	63	40	M16	5		
MXG6040H-M16		40	6	63	40	M16	6		
MXG6042H-M16		42	6	63	40	M16	6		

E45HN09 高進給端銑刀

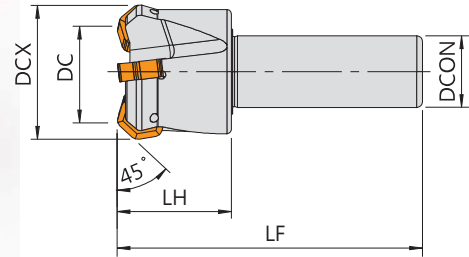

▼Recommended Inserts 建議刀片品牌：KENNAMETAL

Standard with Coolant thru
Double sided insert with 12 cutting edges

Order No.	Insert	Dimensions(mm)					Screw	Wrench
		刀徑	長度	頭長	柄徑	刃數		
Right / Left		DC	LF	LH	DCON	I No.		
E45HN09-D4003R	HNGJ0905 HNPJ0905	40	107	50	32	3	CSR4010	DBIT-T15
E45HN09-D5004R		50	107	50	32	4		

F45HN09 殼型銑刀

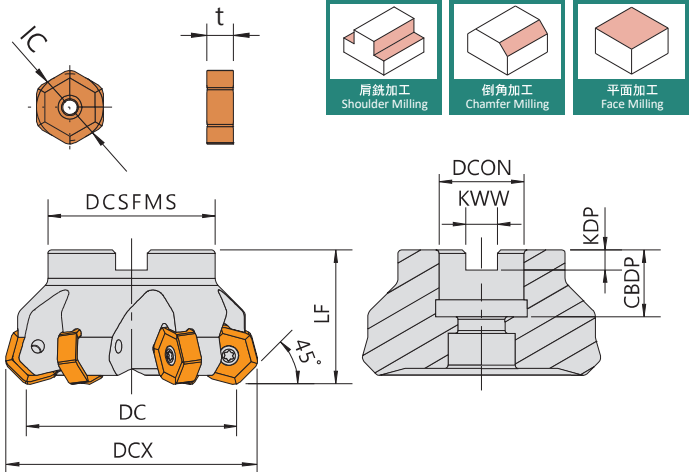

▼Recommended Inserts 建議刀片品牌：KENNAMETAL

Standard with Coolant thru

Order No.	Insert	Dimensions(mm)					Screw	Wrench	
		刀徑	長度	孔徑		刃數			
Right / Left		DC	LF	DCON	DCON(inch)	I No.	Arbor Type		
F45HN09-D050A04R/L	HNGJ0905 HNPJ0905	50	40	22	-	4	Fig.1	CSR4010	DBIT-T15
F45HN09-D063A06R/L		63	40	22	1"	6	Fig.1		
F45HN09-D080A06R/L		80	50	27	1"	6	Fig.1		
F45HN09-D100B08R/L		100	50	32	1-1/4"	8	Fig.2		
F45HN09-D125B10R/L		125	63	40	1-1/2"	10	Fig.2		
F45HN09-D160C12R/L		160	63	40	-	12	Fig.3		

EXN

高進給端銑刀

High Feed End mill

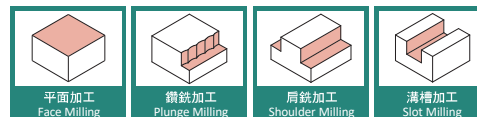

公制型

Metric type

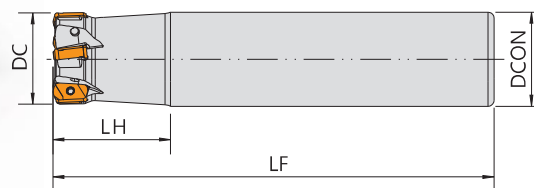

▼Recommended Inserts 建議刀片品牌：TUNGALOY/ACC

Double sided insert with 4 cutting edges

Order No.	Insert	Dimensions(mm)					Screw	Wrench
		刀徑	柄徑	頭長	長度	刃數		
Right / Left		DC	DCON	LH	LF	I No.		
Short-neck Type 短頸型								
EXN03R1602S16	LNMU0303	16	16	20	100	2	CS2508PS	FT-8P
EXN03R1702S16		17	16	20	100	2		
EXN03R2003S20		20	20	25	130	3		
EXN03R2103S20		21	20	25	130	3		
EXN03R2504S25		25	25	30	140	4		
EXN03R2604S25		26	25	30	140	4		
EXN03R3205S32		32	32	40	150	5		
EXN03R3305S32		33	32	40	150	5		
EXN03R3505S32		35	32	40	150	5		
Long-neck Type 長頸型								
EXN03R1602S16-B30	LNMU0303	16	16	30	100	2	CS2508PS	FT-8P
EXN03R1702S16-B30		17	16	30	100	2		
EXN03R2003S20-B50		20	20	50	130	3		
EXN03R2103S20-B50		21	20	50	130	3		
EXN03R2504S25-B60		25	25	60	140	4		
EXN03R2604S25-B60		26	25	60	140	4		
EXN03R3205S32-B70		32	32	70	150	5		
EXN03R3305S32-B70		33	32	70	150	5		
EXN03R3505S32-B70		35	32	70	150	5		
Long Shank 長柄型								
EXN03R1602S16-L150B50	LNMU0303	16	16	50	150	2	CS2508PS	FT-8P
EXN03R2003S20-L160B80		20	20	80	160	3		
EXN03R2504S25-L180B100		25	25	100	180	4		

EXN

高進給端銑刀

High Feed End Mill

英制型

Inch type

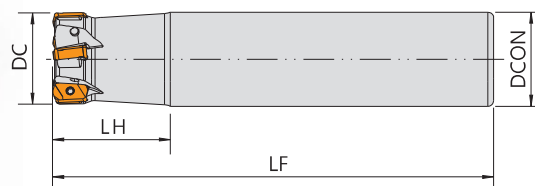
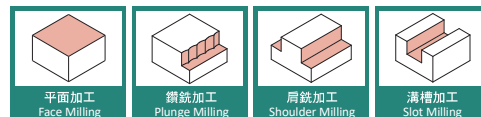

▼Recommended Inserts 建議刀片品牌：TUNGALOY/ACC

Double sided insert with 4 cutting edges

Order No.	Insert	Dimensions(inch)					Screw	Wrench
		刀徑 DC	柄徑 DCON	頭長 LH	長度 LF	刃數 I No.		
EXN03R062U0062-02	LNMU0303	.6250	.625	1.250	4.000	2	CS2508PS	FT-8P
EXN03R068U0062-02		.6880	.625	1.250	4.000	2		
EXN03R075U0075-03		.7500	.750	2.000	5.000	3		
EXN03R087U0075-03		.8750	.750	2.000	5.000	3		
EXN03R100U0100-04		1.0000	1.000	2.500	5.500	4		
EXN03R112U0100-04		1.1250	1.000	2.500	5.500	4		
EXN03R125U0125-06		1.2500	1.250	3.000	6.000	6		

TXN

殼型銑刀

High Feed Shell End Mill

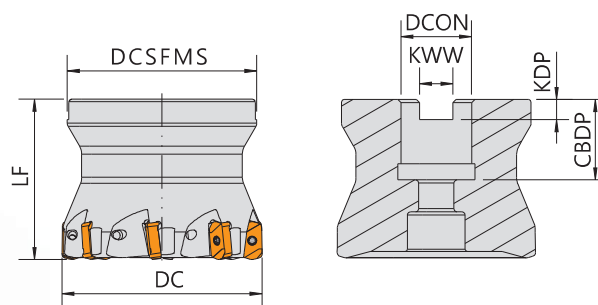
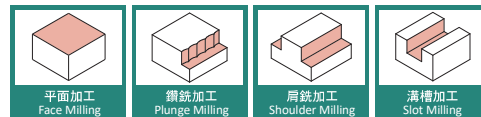

▼Recommended Inserts 建議刀片品牌：TUNGALOY/ACC

Double sided insert with 4 cutting edges

Order No.	Insert	Dimensions(mm)					Screw	Wrench
		刀徑 DC	長度 LF	孔徑 DCON	孔徑 DCON(inch)	刃數 I No.		
TXN03R4006	LNMU0303	40	40	16	-	6	CS2508PS	FT-8P
TXN03R5007		50	50	22	1"	7		
TXN03R6308		63	50	22	1"	8		

HXN

鎖牙式銑刀

Modular End Mill

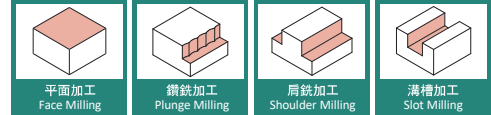
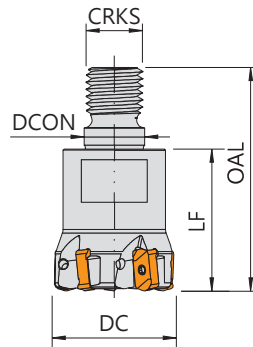

▼Recommended Inserts 建議刀片品牌：TUNGALOY/ACC

Double side insert with 4 cutting edges

Order No.	Insert	Dimensions(mm)						Screw	Wrench
		刀徑 DC	柄徑 DCON	總長 OAL	長度 LF	螺紋 CRKS	刃數 I No.		
HXN03R1602	LNMU0303	16	8.5	42	25	M8	2	CS2508PS	FT-8P
HXN03R1702		17	8.5	42	25		2		
HXN03R2003		20	10.5	49	30	M10	3		
HXN03R2103		21	10.5	49	30		3		
HXN03R2504		25	12.5	57	35	M12	4		
HXN03R2604		26	12.5	57	35		4		
HXN03R3205		32	17	63	40	M16	5		
HXN03R3305		33	17	63	40		5		
HXN03R3505		35	17	63	40		5		

▼Inserts 刀片：

●=Stock / ◎=1st Choice 首選 / ○=2nd Choice 次選 / X=Not Recommend 不建議

Tolerance Class 精度	P 鋼 Carbon Steels	M 不鏽鋼 Stainless Steels	K 鑄鐵 Cast Iron	S 高溫合金 Superalloys	H 高硬度 Hard Materials	Dimensions(mm) 尺寸				
M級	◎	◎	◎	◎	◎	IC	t	B	r	Max.ap
LNMU0303ZER-MJ	●	●	●	●	●	6.0	4.3	6.0	1.2	1
LNMU0303ZER-ML	●	●	●			6.0	4.3	6.0	1.2	1

F90LN15

殼型銑刀

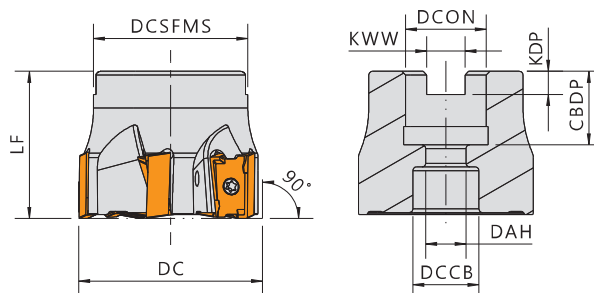
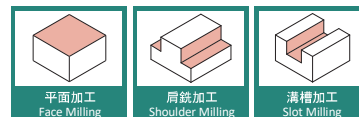

▼Recommended Inserts 建議刀片品牌：KENNAMETAL

Order No.	Insert	Dimensions(mm)				Screw	Wrench
Right / Left		刀徑	長度	孔徑			
		DC	LF	DCON	DCON(inch)		
F90LN15-040-04	LNGU15T608SRGEM	40	40	16	-	CSR4010	DBIT-T15
F90LN15-050-05		50	46	22	-		
F90LN15-063-06		63	46	22	1"		
F90LN15-080-07		80	50	27	1"		

MWRC 圓角端銑刀

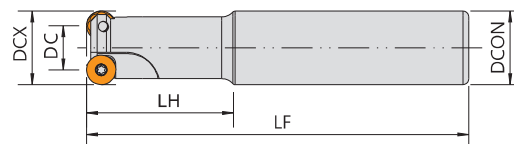
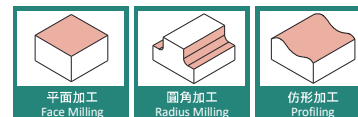

▼Recommended Inserts 建議刀片品牌：SUMITOMO

Order No.	Insert	Dimensions(mm)						Screw	Wrench
		最大刀徑 DCX	刀徑 DC	柄徑 DCON	長度 LF	頭長 LH	刃數 I No.		
Right / Left									
MWRC12-12-110-08-40	QPMT0803	12	4	12	110	40	1	CS25055 / CS25052S	DT-8
MWRC12-12-150-08-70		12	4	12	150	70	1		
MWRC16-16-120-08-50		16	8	16	120	50	1	CS25062S	
MWRC16-16-150-08-70		16	8	16	150	70	1		
MWRC20-20-130-08-50		20	12	20	130	50	2		
MWRC20-20-180-08-100		20	12	20	180	100	2		
MWRC25-25-130-10-50	QPMT10T3	25	15	25	130	50	2	CS35090	DBIT-T15
MWRC25-25-180-10-100		25	15	25	180	100	2		
MWRC32-32-130-10-50		32	22	32	130	50	3		
MWRC32-32-200-10-120		32	22	32	200	120	3		
MWRC32-32-300-10-180		32	22	32	300	180	3		
MWRC32-32-200-12-120	QPMT1204	32	20	32	200	120	2	CS40090	
MWRC40-32-170-16	QPMT1606	40	24	32	170	50	2	CS50100	DBIT-T20
MWRC40-32-250-16		40	24	32	250	50	2		
MWRC50-32-170-16		50	34	32	170	50	3	CS50130	
MWRC50-32-250-16		50	34	32	250	50	3		

EM#R

圓角端銑刀

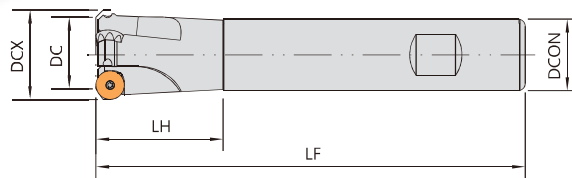
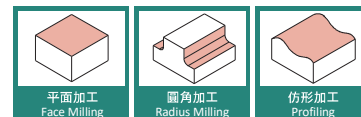

▼Recommended Inserts 建議刀片品牌：MITSUBISHI

Order No.	Insert	Dimensions(mm)						Screw	Wrench
		最大刀徑	刀徑	柄徑	長度	頭長	刃數		
Right / Left		DCX	DC	DCON	LF	LH	I No.		
EM4R-D16K01	RPMT08T2MOE	16	8	16	120	30	1	CS25062S	DT-8
EM4R-D16M01		16	8	16	150	30	1		
EM4R-D16R01		16	8	16	200	30	1		
EM4R-D20K02		20	12	20	120	30	2		
EM4R-D20M02		20	12	20	150	30	2		
EM4R-D20R02		20	12	20	200	30	2		
EM4R-D25K03-20		25	17	20	125	30	3		
EM4R-D25K03		25	17	20	120	35	3		
EM4R-D25M03-20		25	17	20	150	35	3		
EM4R-D25M03		25	17	25	150	35	3		
EM4R-D25R03		25	17	25	200	35	3		
EM5R-D25K02	RPMT10T3MOE	25	15	25	120	40	2	CS35090	DBIT-T15
EM5R-D25M02		25	15	25	150	40	2		
EM5R-D25R02		25	15	25	200	40	2		
EM5R-D30K03		30	20	25	120	40	3		
EM5R-D30M03		30	20	25	150	40	3		
EM5R-D30R03		30	20	25	200	40	3		
EM5R-D35K03		35	25	32	120	40	3		
EM5R-D35M03		35	25	32	150	40	3		
EM5R-D35R03		35	25	32	200	50	3		
EM6R-D35K02	RPMT1204MOE	35	23	32	120	50	2	CS35090	DBIT-T15
EM6R-D35M02		35	23	32	150	50	2		
EM6R-D35R02		35	23	32	200	50	2		
EM6R-D40K03		40	28	32	120	50	3		
EM6R-D40M03		40	28	32	150	50	3		
EM6R-D40R03		40	28	32	200	50	3		
EM6R-D50R04		50	38	32	200	50	4		

MS5R 圓角殼型銑刀

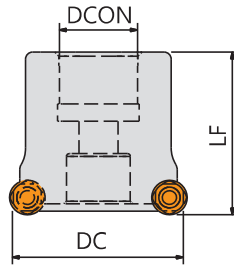

RPMT10T3MOE

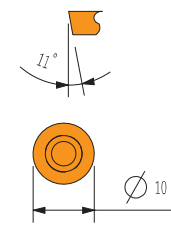

For indexable inserts

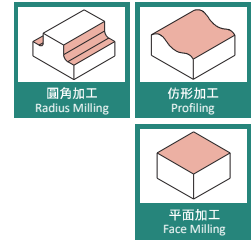

▼Recommended Inserts 建議刀片品牌：MITSUBISHI

Order No.	Insert	Dimensions(mm)				Screw	Wrench
		刀徑 DC	長度 LF	孔徑 DCON	刃數 I No.		
Right / Left							
MS5R-050A04R	RPMT10T3MOE RPMW10T3MOE	50	46	22	4	CS35090	DBIT-T15
MS5R-063A05R		63	46	22	5		
MS5R-080A06R		80	50	27	6		
MS5R-100B07R		100	50	32	7		

MS6R 圓角殼型銑刀



RPMT1204MOE

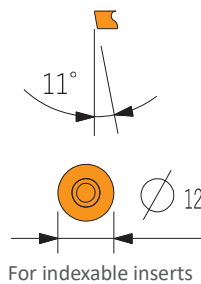

For indexable inserts

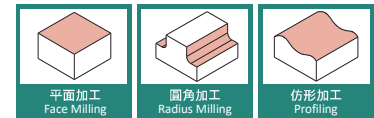
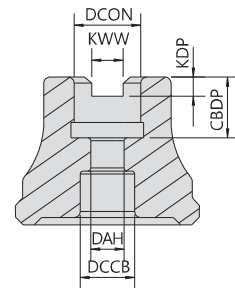
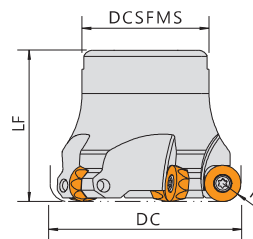

▼Recommended Inserts 建議刀片品牌：MITSUBISHI

Order No.	Insert	Dimensions(mm)				Screw	Wrench
		刀徑 DC	長度 LF	孔徑 DCON	刃數 I No.		
Right / Left							
MS6R-050A04R	RPMT1204MOE RPMW1204MOE	50	46	22	4	CS35090	DBIT-T15
MS6R-063A05R		63	46	22	5		
MS6R-080A06R		80	50	27	6		
MS6R-100B07R		100	50	32	7		
MS6R-125B08R		125	54	40	8		
MS6R-080A06RN	RPMT1204MOE RPMW1204MOE	80	50	27	6	CS40090	DBIT-T15
MS6R-100B07RN		100	50	32	7		

▼Inserts 刀片：

●=Stock / ◎=1st Choice 首選 / ○=2nd Choice 次選 / X=Not Recommend 不建議

Tolerance Class 精度	P	鋼 Carbon Steels	◎	◎	◎	◎				
	M	不鏽鋼 Stainless Steels	◎	◎	◎	◎				
M級	K	鑄鐵 Cast Iron	◎		◎					
Specification 規格			Grade 材質				Dimensions(mm) 尺寸			
			VS203	SPTIEH	F7030	VP15TF	IC	T	d	α
		RPMT1204MOE			●	●	12	4.76	4.4	11

ERD

圓角端銑刀

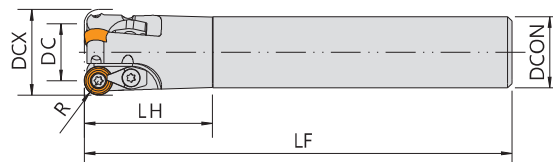
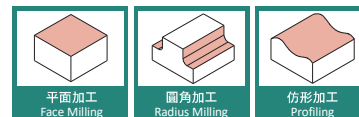

▼Recommended Inserts 建議刀片品牌：HITACHI

Order No.	Insert	Dimensions(mm)						Screw	Clamp	Wrench
Right / Left		最大刀徑	刀徑	柄徑	長度	頭長	刃數			
		DCX	DC	DCON	LF	LH	I No.			
ERD10-2525M02	RDMT10T3	25	15	25	150	45	2	CS35091		DBIT-T15
ERD10-2525R02		25	15	25	200	45	2			
ERD10-3025M03		30	20	25	150	45	3			
ERD10-3025R03		30	20	25	200	45	3			
ERD10-3532M03		35	25	32	150	45	3			
ERD10-3532R03		35	25	32	200	45	3			

▼Inserts 刀片：

●=Stock / ◎=1st Choice 首選 / ○=2nd Choice 次選 / X=Not Recommend 不建議

Tolerance Class 精度	P	鋼 Carbon Steels	◎	◎	◎	◎				
	M	不鏽鋼 Stainless Steels	◎	◎	◎	◎				
M級	K	鑄鐵 Cast Iron	◎		◎					
Specification 規格			Grade 材質				Dimensions(mm) 尺寸			
◎			VS203	SPTIEH	F7030	VP15TF	IC	T	d	α
RDMT10T3MOE			●	●	●	●	10	3.97	4.5	15

MSRD10 圓角殼型銑刀

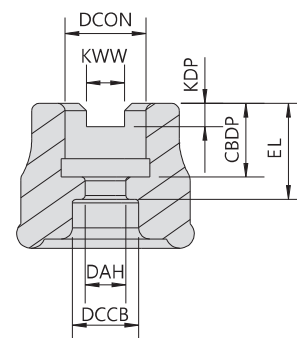
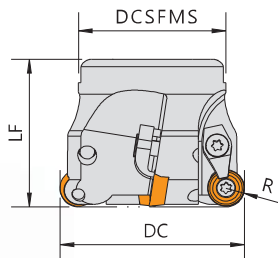

▼Recommended Inserts 建議刀片品牌：HITACHI

Order No.	Insert	Dimensions(mm)				Screw	Clamp	Wrench
Right / Left		刀徑 DC	長度 LF	孔徑 DCON	刃數 I No.			
MSRD10-050-04	RDMT10T3	50	40	22	4	CS35091	CP50-27AS	DBIT-T15
MSRD10-063-05		63	40	22	5			
MSRD10-080-06		80	50	27	6			
MSRD10-100-07		100	50	32	7			
MSRD10-125-08		125	55	40	8			

MSRD12 圓角殼型銑刀

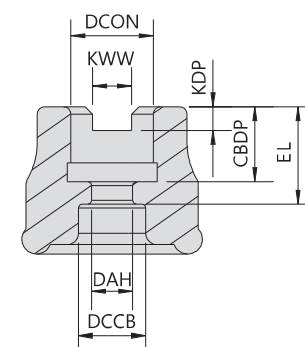
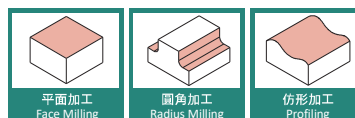
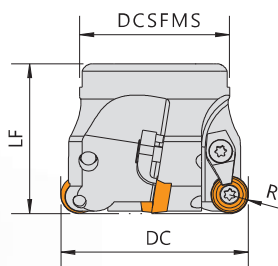

▼Recommended Inserts 建議刀片品牌：HITACHI

Order No.	Insert	Dimensions(mm)				Screw	Clamp	Wrench
Right / Left		刀徑 DC	長度 LF	孔徑 DCON	刃數 I No.			
MSRD12-050-04	RDMT1204	50	40	22	4	CS4009P	CP50-27AS	DBIT-TP15
MSRD12-063-05		63	40	22	5			
MSRD12-080-06		80	50	27	6			
MSRD12-100-07		100	50	32	7			
MSRD12-125-08		125	55	40	8			

ERD

鎖牙式銑刀

Modular End Mill

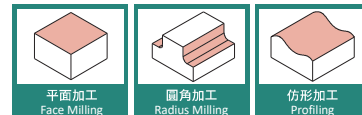
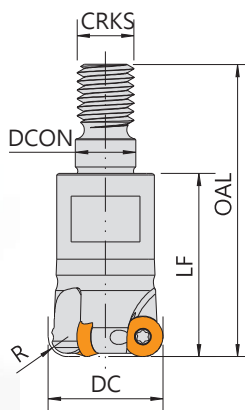

▼Recommended Inserts 建議刀片品牌：HITACHI

Order No.	Insert	Dimensions(mm)						Screw	Wrench
		刀徑	柄徑	總長	長度	螺紋	刃數		
Right / Left		DC	DCON	OAL	LF	CRKS	I No.		
ERD05-09-2T-M05	RDHX0501	9	5.5	27.5	15	M5	2	CS20038	FT-6
ERD05-10-2T-M05		10	5.5	28.5	16		2		
ERD05-11-2T-M05		11	5.5	30.5	18		2		
ERD05-12-2T-M06		12	6.5	32.5	18	M6	2		
ERD05-13-2T-M06		13	6.5		18		2		
ERD05-13-3T-M06		13	6.5		18		3		
ERD05-16-4T-M08		41	16	8.5	23	M8	4		
ERD05-17-4T-M08			17	8.5	23		4		
ERD07-12-2T-M06	RDMT0702	12	6.5	37.5	23	M6	2	CS25055 / CS25052S	FT-8
ERD07-15-2T-M08		15	8.5		23		2		
ERD07-16-2T-M08		41	16	8.5	23	M8	2		
ERD07-16-3T-M08			16	8.5	23		3		
ERD07-17-2T-M08		43	17	8.5	25		2		
ERD07-17-3T-M08			17	8.5	25	3			
ERD07-20-3T-M10		51	20	10.5	32	M10	3		
ERD07-21-2T-M10			21	10.5	32		2		
ERD07-21-3T-M10			21	10.5	32		3		
ERD07-22-3T-M10			22	10.5	32		3		
ERD07-25-4T-M12		57	25	12.5	35	M12	4		
ERD07-26-4T-M12			26	12.5	35		4		
ERD07-26-5T-M12			26	12.5	35		5		
ERD07-35-5T-M16		65	17	43	M16	5			

ER390

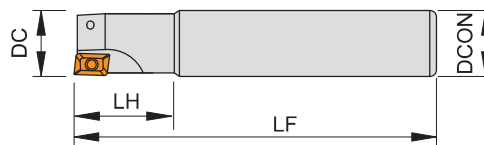
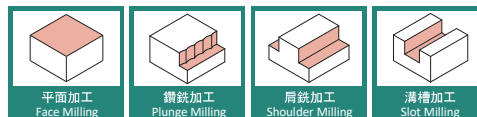

▼Recommended Inserts 建議刀片品牌：SANDVIK

Order No.	Insert	Dimensions(mm)					Screw	Wrench
		刀徑 DC	長度 LF	頭長 LH	柄徑 DCON	刃數 I No.		
ER390-162S16-100	R390-11T3	16	100	20	16	2	CS25055 / CS25052S	DT-8
ER390-162S16-150		16	150	20	16	2		
ER390-172S16-150		17	150	20	16	2		
ER390-203S20-110		20	110	25	20	3	CS25062S	
ER390-203S20-150		20	150	25	20	3		
ER390-213S20-150		21	150	25	20	3		
ER390-253S25-200		25	200	30	25	3		
ER390-254S25-120		25	120	30	25	4		
ER390-254S25-150		25	150	30	25	4		
ER390-264S25-150		26	150	30	25	4		
ER390-324S32-200		32	200	40	32	4		
ER390-325S32-150		32	150	40	32	5		
ER390-335S32-150		33	150	40	32	5		

R390 殼型銑刀

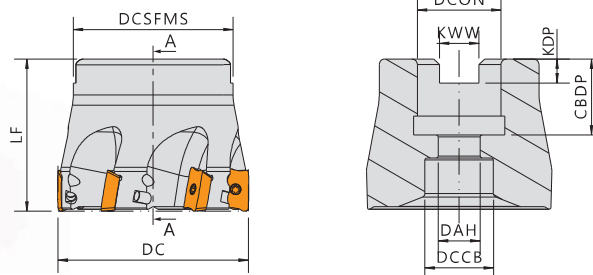
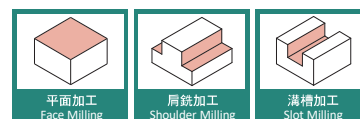
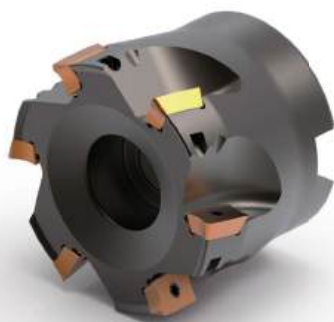

▼Recommended Inserts 建議刀片品牌：SANDVIK

Order No.	Insert	Dimensions(mm)				Screw	Wrench
		刀徑 DC	長度 LF	柄徑 DCON	刃數 I No.		
R390-F50-6T	R390-11T3	50	40	22	6	CS25062S	FT-8
R390-F52-5T		52	40	22	5		
R390-F63-8T		63	40	22	8		
R390-F66-7T		66	40	22	7		
R390-F80-8T		80	50	27	8		

ER390

鎖牙式銑刀

Modular End Mill

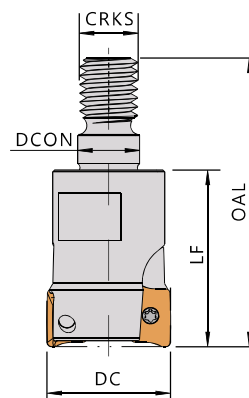
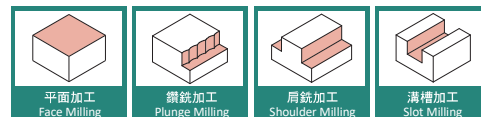

▼ Recommended Inserts 建議刀片品牌 : SANDVIK

Order No.	Insert	Dimensions(mm)						Screw	Wrench
		刀徑	柄徑	總長	長度	螺紋	刃數		
Right / Left		DC	DCON	OAL	LF	CRKS	I No.		
ER390-16-2T-M08-11	R390-11T3	16	8.5	43	25	M8	2	CS25055	FT-8
ER390-17-2T-M08-11		17	8.5	43	25	M8	2		
ER390-21-2T-M10-11		21	10.5	49	30	M10	2		
ER390-26-2T-M12-11		26	12.5	57	35	M12	2		

E90SD06

直角端銑刀

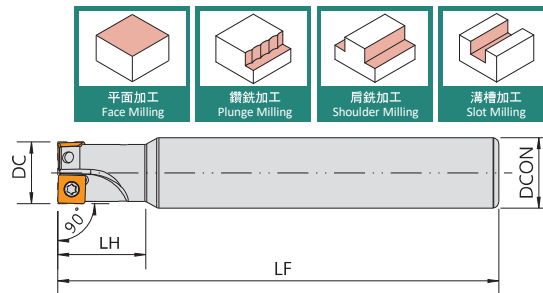

▼Recommended Inserts 建議刀片品牌：KENNAMETAL/KYOCERA/ACC

Order No.	Insert	Dimensions(mm)					Screw	Wrench
		刀徑	長度	頭長	柄徑	刃數		
Right / Left		DC	LF	LH	DCON	I No.		
E90SD06-D10H01	SDMT0603	10	100	20	12	1	CS25055 / CS25052S	DT-8
E90SD06-D12H01		12	100	20	12	1		
E90SD06-D14H02		14	100	20	16	2		
E90SD06-D16H02		16	100	20	16	2		
E90SD06-D20K03		20	125	20	20	3		

E45SD06

直角倒角銑刀

Chamfer Milling Cutter

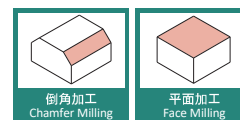
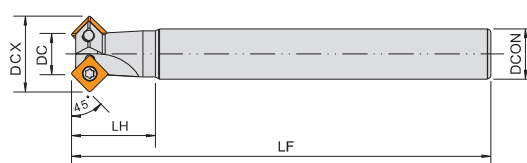
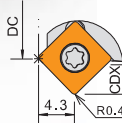

▼Recommended Inserts 建議刀片品牌：KENNAMETAL/KYOCERA/ACC

Order No.	Insert	Dimensions(mm)							Screw	Wrench
		刀徑	柄徑	最大刀徑	長度	頭長	最大切深	刃數		
Right / Left		DC	DCON	DCX	LF	LH	CDX	I No.		
E45SD06-D06H01-12	SDMT0603	6	12	14.2	100	20	2	1	CS25055 / CS25052S	DT-8
E45SD06-D10H02-12		10	12	18.2	100	20	3.5	2		
E45SD06-D12H02		12	16	20.2	100	25	3.5	2	CS25062S	
E45SD06-D16H03-20		16	20	24.3	100	25	3.5	3		
E45SD06-D20K03		20	20	28.3	125	25	3.5	3		

▼Inserts 刀片：

●=Stock / ◎=1st Choice 首選 / ○=2nd Choice 次選 / X=Not Recommend 不建議

Tolerance Class 精度	P	鋼 Carbon Steels	◎		◎						
	M	不鏽鋼 Stainless Steels	○	○	◎						
M級	K	鑄鐵 Cast Iron		◎							
Specification 規格			Grade 材質				Dimensions(mm) 尺寸				
			AK100	TH200	PR660	PR905	IC	T	d	α	r
SDMT060304			●	●			6.35	3.18	2.8	15	0.4
SDMT080308					●	●	8	3.18	3.4	15	0.8
SDMT120408					●		12.7	4.76	4.4	15	0.8

E90SD12

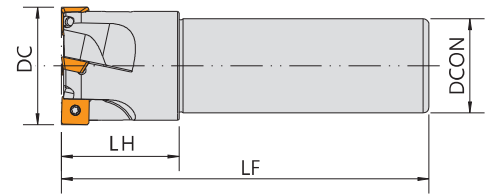
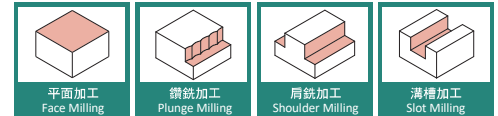

▼Recommended Inserts 建議刀片品牌：KENNAMETAL/KYOCERA

Order No.	Insert	Dimensions(mm)					Screw	Wrench
		刀徑	長度	頭長	柄徑	刃數		
Right / Left		DC	LF	LH	DCON	I No.		
E90SD12-D32K02	SDPT1204PDEN	32	125	35	32	2	CS35090	DBIT-T15
E90SD12-D40K02		40	125	40	32	3		
E90SD12-D50K03		50	125	40	32	5		

F90SD12 殼型銑刀

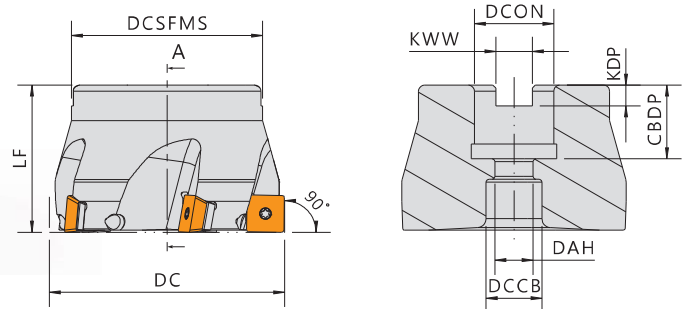
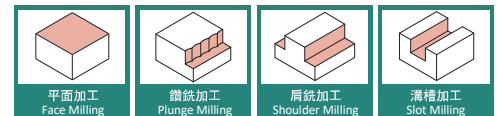
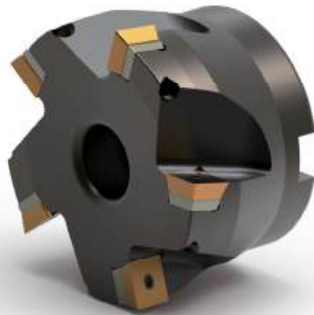

▼少刃型/含墊片

▼Recommended Inserts 建議刀片品牌：KENNAMETAL

Order No.	Insert	Dimensions(mm)					Shim	Shim Screw	Screw	Wrench
		刀徑	長度	孔徑		刃數				
Right / Left		DC	LF	DCON	DCON(inch)	I No.				
F90SD12-D050A03RSH	SDPT1204	50	46	22	-	3	SMS-321	SN535	CS35119S	DBIT-T15
F90SD12-D063A06RH		63	46	22	1"	6	-	-		
F90SD12-D080B05RS		80	50	27	1"	5	SMS-321	SN535		
F90SD12-D100B06RS		100	50	32	1-1/4"	6	SMS-321	SN535		
F90SD12-D125B12R		125	61	40	1-1/2"	12	-	-		

F90SD12-D100B06RS with shim 含墊片

F90SD12-D050A05RH with coolant thru 無墊片+含油孔

F90SD12-D063A04RSH with shim and cooling channel 墊片+含油孔

F90SD12-D080B07R without shim and cooling channel 無墊片+無油孔

SSD12 殼型銑刀

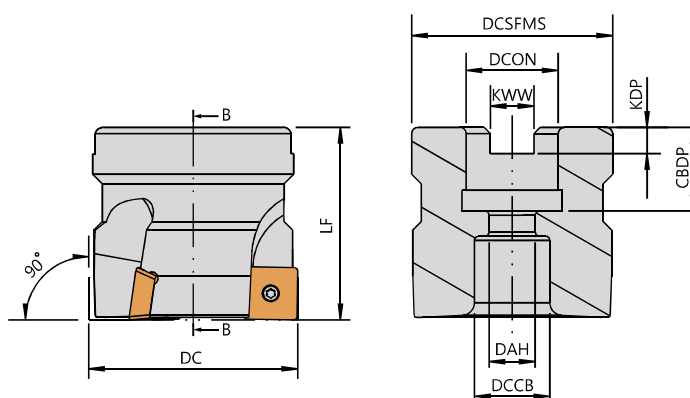
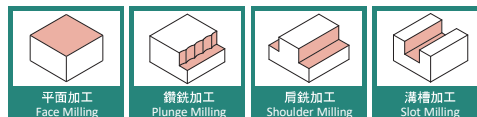

▼多刃型/無墊片

▼Recommended Inserts 建議刀片品牌: KENNAMETAL

Standard with Coolant thru

Order No.	Insert	Dimensions(mm)					Screw	Wrench
		刀徑	長度	孔徑		刃數		
Right / Left		DC	LF	DCON	DCON(inch)	I No.		
SSD12-040-04RH	SDPT1204 SDMT1204 SDMT1205	40	40	16	-	4	CS35119S	DBIT-T15
SSD12-050-05RH		50	40	22	-	5		
SSD12-063-06RH		63	40	22	1"	6		
SSD12-080-07RH		80	50	27	1"	7		
SSD12-100-08RH		100	50	32	1-1/4"	8		

E45SE12 倒角銑刀

Chamfer Milling Cutter

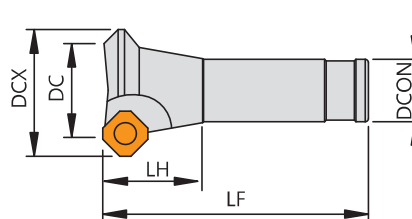
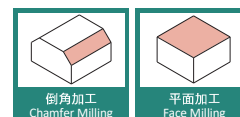

Order No.	Insert	Dimensions(mm)						Screw	Wrench
		刀徑	柄徑	最大刀徑	長度	頭長	刃數		
Right / Left		DC	DCON	DCX	LF	LH	I No.		
E45SE12-D25H02	SEHW1204AFTN SEKT1204	25	20	37	100	31	2	CS45090	DBIT-T15
E45SE12-D30H02		30	20	42	100	31	2		
E45SE12-D40J03		40	25	52	110	37	3		
E45SE12-D50K04		50	32	62	125	37	4		
E45SE12-D63M05		63	32	75	150	37	5		

E90SE09 直角端銑刀

New generation of 90°
Face and shoulder milling cutter with screw-
on inserts Low costs per cutting edge through
Indexable insert with four edges

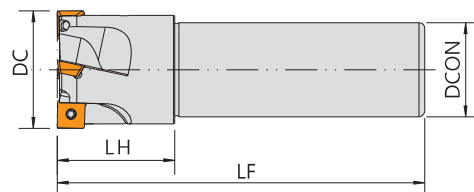
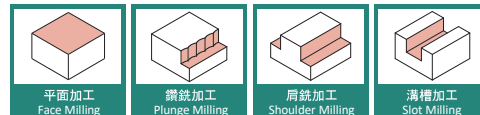

▼Recommended Inserts 建議刀片品牌：KYOCERA

Order No.	Insert	Dimensions(mm)					Screw	Wrench
		刀徑	長度	頭長	柄徑	刃數		
Right / Left		DC	LF	LH	DCON	I No.		
E90SE09-D25JX02	SEMM09T3	25	120	30	25	2	CS30070	DBIT-T10
E90SE09-D32K03		32	125	35	32	3		
E90SE09-D40K04		40	125	40	32	4		
E90SE09-D50K05		50	125	40	32	5		

F90SE09 直角殼型銑刀

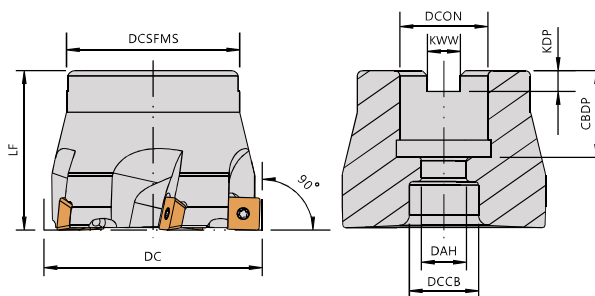

▼Recommended Inserts 建議刀片品牌：KYOCERA

Order No.	Insert	Dimensions(mm)				Screw	Wrench	
		刀徑	長度	孔徑				刃數
Right / Left		DC	LF	DCON	DCON(inch)	I No.		
F90SE09-D40A04R	SEMM09T3	40	40	16	-	4	CS30070	DBIT-T10
F90SE09-D50A05R		50	46	22	-	5		
F90SE09-D63A05R		63	46	22	1"	5		
F90SE09-D80B06R		80	50	27	1"	6		
F90SE09-D100B08R		100	50	32	1-1/4"	8		
F90SE09-D125B10R		125	55	40	1-1/2"	10		

▼Inserts 刀片：

●=Stock / ◎=1st Choice 首選 / ○=2nd Choice 次選 / X=Not Recommend 不建議

Tolerance Class 精度	P	鋼 Carbon Steels	○	◎				
	M	不鏽鋼 Stainless Steels	○	◎				
M級	K	鑄鐵 Cast Iron	◎					
Specification 規格		Grade 材質		Dimensions(mm) 尺寸				
		AK105	TP205	IC	T	d	α	r
SEMM09T308PESR		●	●	9.52	3.97	3.4	15	0.8

WSX445

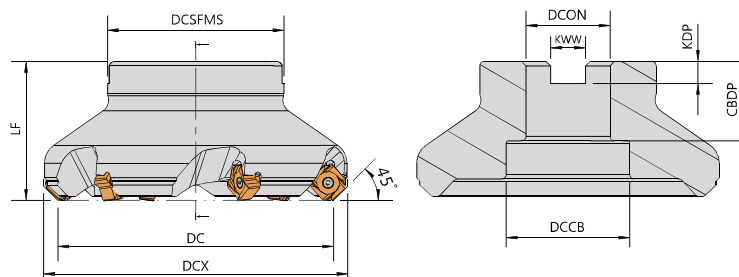
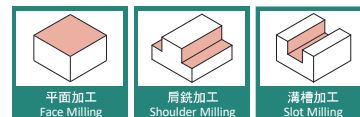

▼Recommended Inserts 建議刀片品牌：MITSUBISHI

Standard with Coolant thru

Order No.	Insert	Dimensions(mm)						Screw	Wrench
		刀徑	最大刀徑	夾持接觸面直徑	長度	孔徑	刃數		
Right / Left		DC	DCX	DCSFMS	LF	DCON	I No.		
WSX445-050A03	SNMU1408	50	62.9	47	40	22	3	CSR4012PS	IP15
WSX445-050A04		50	62.9	47	40	22	4		
WSX445-063A04		63	75.9	50	40	1"	4		
WSX445-063A05		63	75.9	50	40	1"	5		
WSX445-080A04		80	92.9	56	50	1"	4		
WSX445-080A06		80	92.9	56	50	1"	6		
WSX445-100B05		100	112.9	70	50	1-1/4"	5		
WSX445-100B07		100	112.9	70	50	1-1/4"	7		
WSX445-125B06		125	137.9	80	63	1-1/2"	6		
WSX445-125B08		125	137.9	80	63	1-1/2"	8		
WSX445-160B07		160	172.9	100	63	2"	7		
WSX445-160B10		160	172.9	100	63	2"	10		
WSX445-200C08		200	212.9	175	63	1-7/8"	8		
WSX445-200C12		200	212.9	175	63	1-7/8"	12		

E908

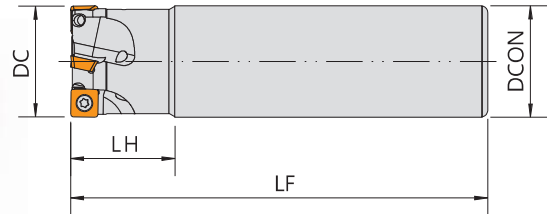

▼Recommended Inserts 建議刀片品牌：SUMITOMO

Standard with Coolant thru

Order No.	Insert	Dimensions(mm)					Screw	Wrench
		刀徑 DC	柄徑 DCON	頭長 LH	長度 LF	刃數 I No.		
Right / Left								
E908-2016-02-110H	SOMT0803 SOET0803	20	16	30	110	2	CS30063	FT-8P
E908-2020-02-110H		20	20	30	110	2		
E908-2220-02-120H		22	20	30	120	2		
E908-2520-02-120H		25	20	30	120	2		
E908-2525-03-120H		25	25	30	120	3		
E908-2825-02-120H		28	25	30	120	2		
E908-3025-03-120H		30	25	30	120	3		
E908-3232-03-120H		32	32	30	120	3		
E908-3332-03-120H		33	32	30	120	3		
E908-4032-03-120H		40	32	30	120	3		
E908-5032-04-120H		50	32	30	120	4		
E908-6332-05-120H		63	32	30	120	5		

E908-2016-02-110 without coolant thru 無油孔

E908-2016-02-110H with coolant thru 含油孔

E908-2016-02-110LH with longer shank and coolant thru 加長型含油孔

E912

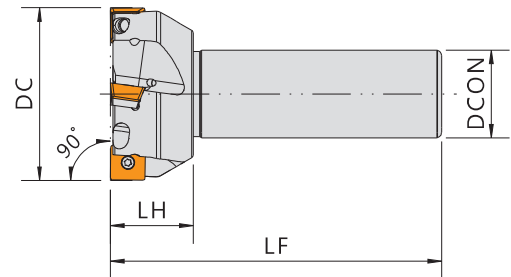
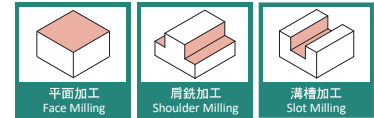

▼Recommended Inserts 建議刀片品牌：SUMITOMO

Standard with Coolant thru

Order No.	Insert	Dimensions(mm)					Screw	Wrench
		刀徑	柄徑	頭長	長度	刃數		
Right / Left		DC	DCON	LH	LF	I No.		
E912-4032-03-120H	SOMT1204	40	32	30	120	3	CS35117S	DBIT-T15
E912-5032-03-120H		50	32	30	120	3		
E912-5032-04-120H		50	32	30	120	4		
E912-6332-04-120H		63	32	30	120	4		
E912-6332-05-120H		63	32	30	120	5		
E912-8032-04-120H		80	32	30	120	4		
E912-8032-06-120H		80	32	30	120	6		

E912-4032-03-120 without coolant thru 無油孔

E912-4032-03-120H with coolant thru 含油孔

E912-4032-03-120LH with longer shank and coolant thru 加長型含油孔

MS908 殼型銑刀

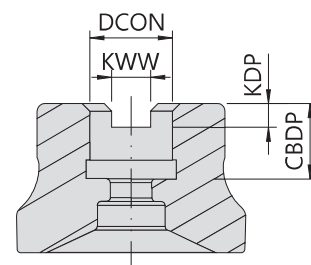
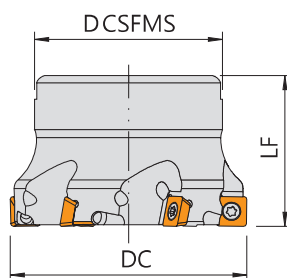
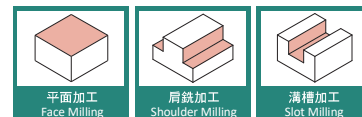

▼Recommended Inserts 建議刀片品牌：SUMITOMO

Standard with Coolant thru

Order No.	Insert	Dimensions(mm)					Screw	Wrench
		刀徑 DC	長度 LF	孔徑 DCON		刃數 I No.		
MS908-040-04H	SOMT0803 SOET0803	40	40	16	-	4	CS30063	FT-8P
MS908-050-05H		50	40	22	-	5		
MS908-063-06H		63	40	22	-	6		
MS908-080-08H		80	50	27	1"	8		
MS908-100-10H		100	50	32	1-1/4"	10		

MS908-040-04 without coolant thru 無油孔
MS908-040-04H with coolant thru 含油孔

MS912 殼型銑刀

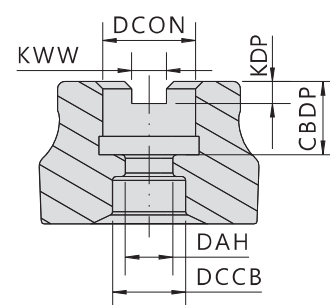
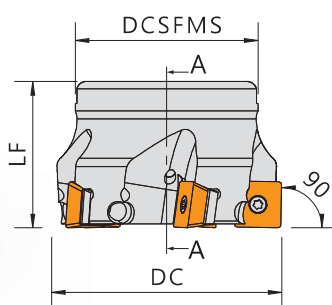
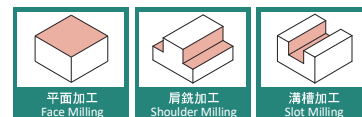

▼Recommended Inserts 建議刀片品牌：SUMITOMO

Standard with Coolant thru

Order No.	Insert	Dimensions(mm)					Shim	Screw		Wrench	
		刀徑 DC	長度 LF	孔徑 DCON		刃數 I No.		六角	星形	DBIT	六角
MS912-063-05H	SOMT1204	63	40	22	1"	5	SMS-321	SN535	CS35117S	DBIT-T15	LW035
MS912-080-06H		80	50	27	1"	6					
MS912-100-07H		100	63	32	1-1/4"	7					

MS908-050-04H with coolant thru 含油孔

ASX400

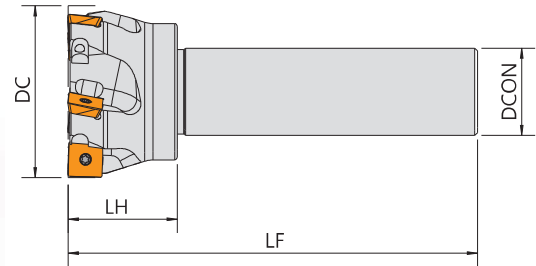
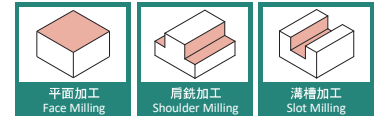

▼Recommended Inserts 建議刀片品牌：MITSUBISHI

Order No.	Insert	Dimensions(mm)					Screw	Wrench
		刀徑 DC	柄徑 DCON	頭長 LH	長度 LF	刃數 I No.		
ASX400R504S20-150	SOMT12T308	50	20	40	150	4	CS35117S	DBIT-T15
ASX400R403S32-150		40	32	40	150	3		
ASX400R635S32-150		63	32	40	150	5		

ASX4RS

W/ SHIM

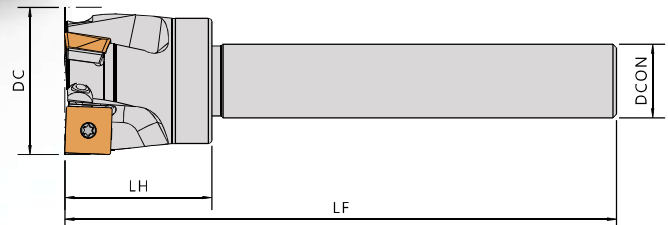
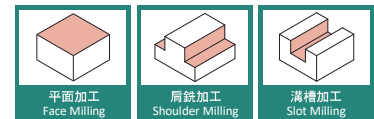

▼Recommended Inserts 建議刀片品牌：MITSUBISHI

Order No.	Insert	Dimensions(mm)					Shim	Shim Screw	Screw	Wrench
		刀徑 DC	柄徑 DCON	頭長 LH	長度 LF	刃數 I No.				
ASX4RS322S20-150	SOMT12T308	32	20	40	150	2	SMS-321	SN535	CS35117S	DBIT-T15
ASX4RS403S20-150		40	20	40	150	3				
ASX4RS504S20-150		50	20	40	150	4				
ASX4RS403S32-150		40	32	40	150	3				
ASX4RS504S32-150		50	32	40	150	4				
ASX4RS635S32-150		63	32	40	150	5				

ASX4-S

W/ SHIM

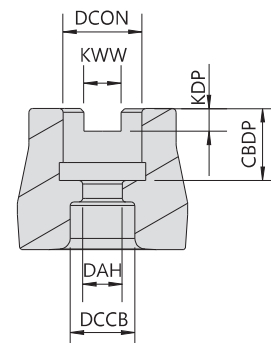
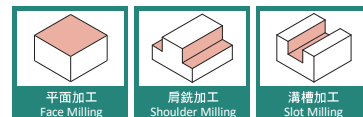
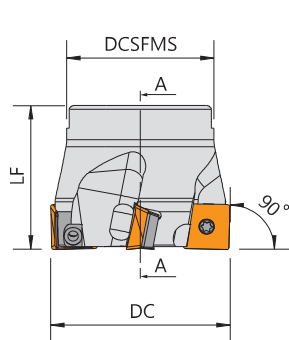

▼Recommended Inserts 建議刀片品牌：MITSUBISHI

Order No.	Insert	Dimensions(mm)						Shim	Shim Screw	Screw	Wrench
Right / Left		刀徑	長度	孔徑		夾持接觸面直徑	刃數				
		DC	LF	DCON	DCON(inch)	DCSFMS	I No.				
ASX4-05004RS	SOMT 12T308	50	40	22	-	41	4	SMS-321	SN535	CS35117S	
ASX4-06305RS		63	40	22	1"	50	5				
ASX4-08004RS		80	50	-	1"	60	4				
ASX4-08006RS		80	50	27	1"	60	6				
ASX4-10007RS		100	50	32	1-1/4"	70	7				
ASX4-12508RS		125	63	40	1-1/2"	80	8				
ASX4-16012RS		160	63	40	2"	100	12				
ASX4-20016RS		200	63	60	-	160	16				
ASX4-25018RS		250	63	60	-	210	18				

MS##S



Positive Axial Rake

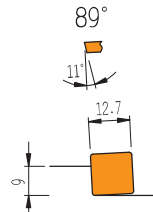

For indexable inserts
SP 1203

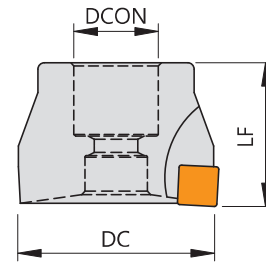
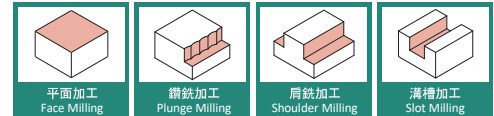

Order No.	Insert	Dimensions(mm)					Clamp	Screw	Spring	Wrench
		刀徑 DC	長度 LF	孔徑 DCON		刃數 I No.				
MS50S	SP**1203	50	46	22	-	3	CP50-3	CSB0617T	SP030	TL-25
MS63S		63	46	27	1"	4				
MS75S		75	46.5	27	1"	5				
MS100S		100	50	32	1-1/4"	6				

ME##C

倒角銑刀

Chamfer Milling Cutter

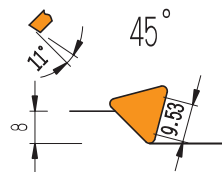

For indexable inserts
TP 1603

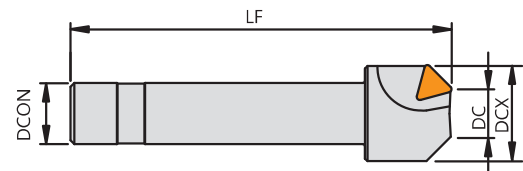
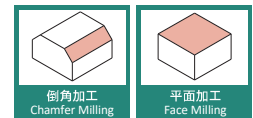

Order No.	Insert	Dimensions(mm)					Clamp	Screw	Wrench
		刀徑 DC	長度 LF	柄徑 DCON	最大刀徑 DCX	刃數 I No.			
ME05Cx12	TP**1603	5	100	12	25	1	CP50-5	CS70-11	LW040
ME05C		5	100	20	25	1			
ME10C		10	120	20	29	2			
ME20Cx12		20	156	12	40	3			
ME20Cx16		20	156	16	40	3			
ME20Cx20		20	156	20	40	3			
ME20Cx25		20	156	25	40	3			

ME##T

TP1102/TP1103

–Straight Shank
90°shoulder.



Positive Axial Rake

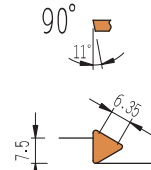

For indexable inserts
TP 1102/TP 1103

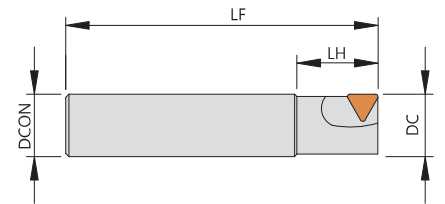
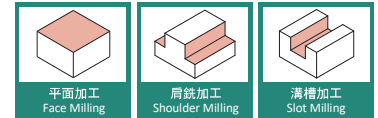

Order No.	Insert	Dimensions(mm)					Clamp	Screw	Wrench
		刀徑 DC	長度 LF	頭長 LH	柄徑 DCON	刃數 I No.			
Right / Left									
ME16T	TP**1102	16	100	26	16	1	CP50-4	CS70-5	LW030
ME18T		18	100	26	16	1			
ME20T		20	100	26	20	2			
ME22T		22	100	26	20	2			
ME25Tx20		25	100	26	20	2			
ME16TxTP1103	TP**1103	16	100	26	16	1	CP50-4	CS70-5	LW030
ME20TxTP1103		20	100	26	20	2			
ME22TxTP1103		22	100	26	20	2			
ME25Tx25xTP1103		25	100	26	25	2			
ME30Tx25xTP1103		30	100	26	25	2			

ME##T

TP1603

–Straight Shank
90°shoulder.

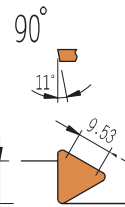

For indexable inserts
TP 1603

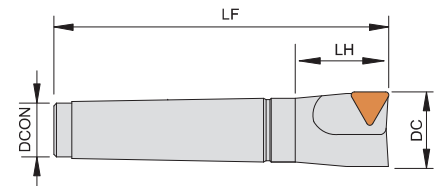
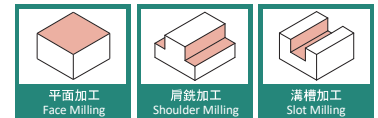

Order No.	Insert	Dimensions(mm)					Clamp	Screw	Spring	Wrench
		刀徑 DC	長度 LF	頭長 LH	柄徑 DCON	刃數 I No.				
Right / Left										
ME30Tx25	TP**1603	30	114	44	25	2	CP50-3	CSB0617T	SP030	TL-25
ME32Tx25		32	114	44	25	2				
ME32Tx32		32	114	44	32	2				
ME35Tx32		35	114	44	32	2				
ME40Tx32		40	114	44	32	3				
ME45Tx32		45	116	46	32	3				
ME50Tx32		50	116	46	32	3				

MS##T

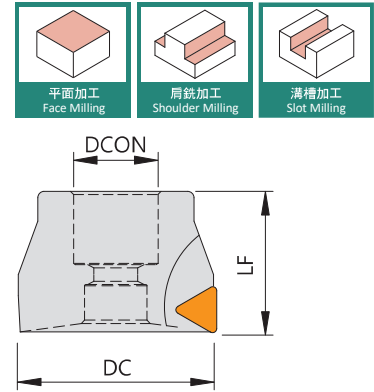
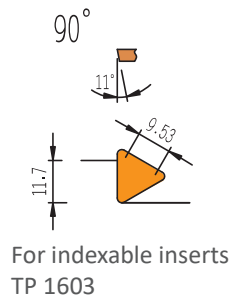

Order No.	Insert	Dimensions(mm)					Clamp	Screw	Spring	Wrench
Right / Left		刀徑 DC	長度 LF	孔徑 DCON DCON(inch)		刃數 I No.				
MS50T	TP**1603	50	46	22	-	3	CP50-3	CSB0617T	SP030	TL-25
MS63T		63	46	27	1"	4				
MS75T		75	46.5	27	1"	5				
MS100T		100	50	32	1-1/4"	6				

MS##T22S

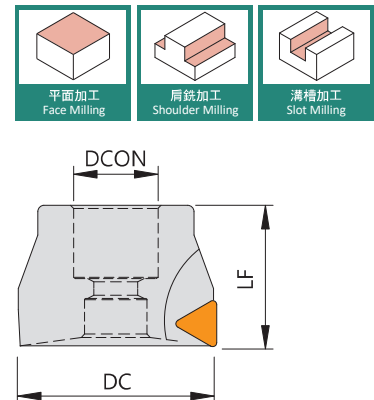
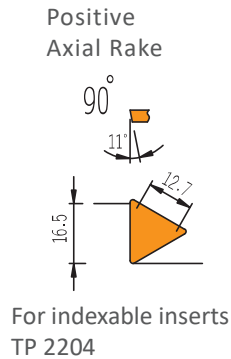

Order No.	Insert	Dimensions(mm)					Shim	Shim Screw	Clamp	Clamp Screw	Wrench
Right / Left		刀徑 DC	長度 LF	孔徑 DCON DCON(inch)		刃數 I No.					
MS63T22S	TP**2204	63	50	22	1"	3	SMT-42	CSA4009F	CP50-10	CS6-8026	LW060
MS80T22S		80	50	27	1"	4					
MS100T22S		100	50	32	1-1/4"	5					
MS125T22S		125	61	40	1-1/2"	6					

E90XN06

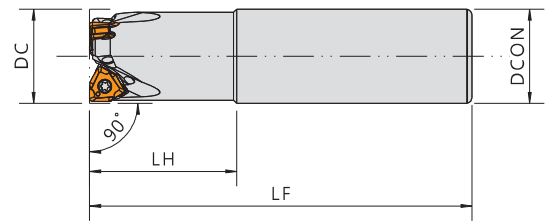
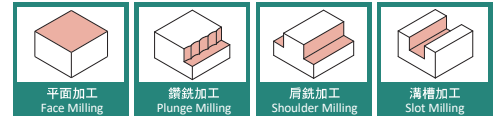

▼Recommended Inserts 建議刀片品牌：SUMITOMO

Standard with Coolant thru

Order No.	Insert	Dimensions(mm)					Screw	Wrench
Right / Left		刀徑	長度	頭長	柄徑	刃數		
		DC	LF	LH	DCON	I No.		
E90XN06-D3203H	XNMU0606	32	130	50	32	3	CSR4010	DBIT-T15
E90XN06-D4004H		40	130	50	32	4		
E90XN06-D5005H		50	130	50	32	5		
		50	150	50	42	5		
E90XN06-D6306H		63	130	50	32	6		
		63	150	50	42	6		
E90XN06-D8007H		80	130	50	32	7		
		80	150	50	42	7		

F90XN06

殼型銑刀

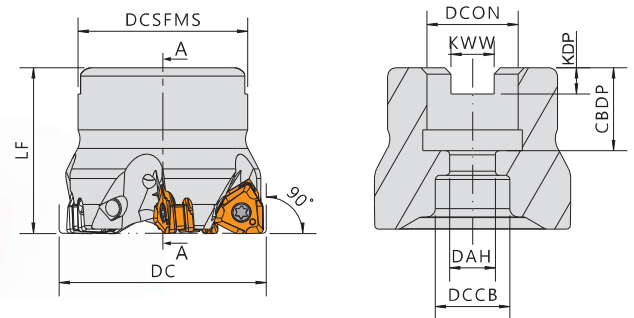
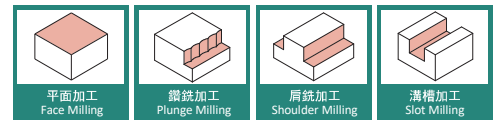

▼Recommended Inserts 建議刀片品牌：SUMITOMO

Standard with Coolant thru

Order No.	Insert	Dimensions(mm)					Screw	Wrench
Right / Left		刀徑	長度	孔徑		刃數		
		DC	LF	DCON	DCON(inch)	I No.		
F90XN06-05005H	XNMU0606	50	40	22	-	5	CSR4010	DBIT-T15
F90XN06-06306H		63	40	22	-	6		
F90XN06-08007H		80	50	27	1"	7		
F90XN06-10008H		100	50	32	1-1/4"	8		
F90XN06-12511H		125	63	40	1-1/2"	11		
F90XN06-16012		160	63	40	2"	12		
F90XN06-20016		200	63	60	1-7/8"	16		

F90XN06-05005H with coolant thru 含油孔

Standard with Coolant thru

VXF

高進給端銑刀

High Feed End Mill

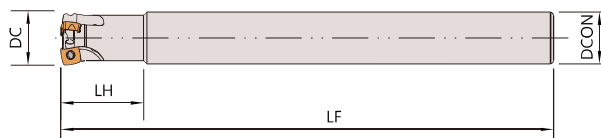
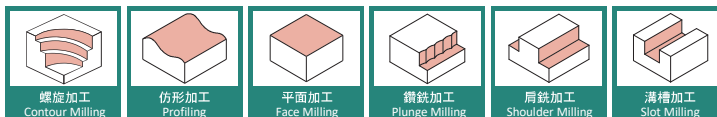

▼Recommended Inserts 建議刀片品牌：WIDIA

Standard with Coolant thru

Order No.	Insert	Dimensions(mm)					Screw	Wrench
		刀徑 DC	長度 LF	頭長 LH	柄徑 DCON	刃數 I No.		
VXF017Z02A16XP07L180	XPPT0703	17	180	25	16	2	CS30053	DT-8
VXF021Z03A20XP07L190		21	190	32	20	3		

VXF-H

鎖牙式銑刀

Modular End Mill

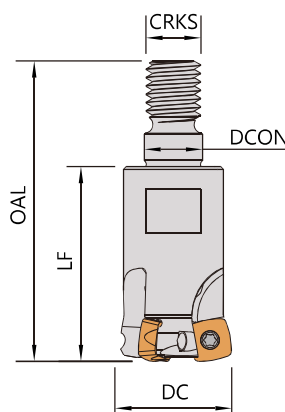

▼Recommended Inserts 建議刀片品牌：WIDIA

Standard with Coolant thru

Order No.	Insert	Dimensions(mm)						Screw	Wrench
		刀徑 DC	柄徑 DCON	總長 OAL	長度 LF	螺紋 CRKS	刃數 I No.		
VXF017Z02M08XP07-H	XPPT0703	17	8.5	43	25	4	2	CS30053	DT-8
VXF021Z03M10XP07-H		21	10.5	54	35	5	3		

E90X06

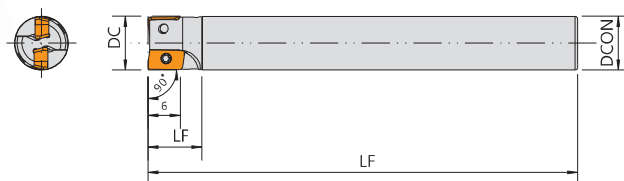
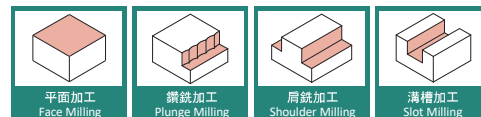

▼Recommended Inserts 建議刀片品牌 : SECO

Order No.	Insert	Dimensions(mm)					Screw	Wrench
		刀徑 DC	長度 LF	頭長 LH	柄徑 DCON	刃數 I No.		
Right / Left								
E90X06-D06F01	XOMT0602	6	80	10	6	1	CS18040	FT-5
E90X06-D08G01		8	90	10	8	1		
E90X06-D10H02		10	100	10	10	2		

HRMDS09

高進給端銑刀

High Feed End Mill

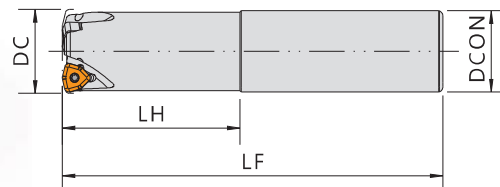

▼Recommended Inserts 建議刀片品牌 : KORLOY

Order No.	Insert	Dimensions(mm)					Screw	Wrench
		刀徑 DC	柄徑 DCON	頭長 LH	長度 LF	刃數 I No.		
Right / Left								
HRMDS09-2525-2TL140	WNMX09T3	25	25	60	140	2	CS30070	FT-10
HRMDS09-2625-2TL140		26	25	60	140	2		
HRMDS09-3025-3TL150		30	25	70	150	3		
HRMDS09-3232-3TL150		32	32	70	150	3		
HRMDS09-3332-3TL150		33	32	70	150	3		
HRMDS09-3532-4TL150		35	32	50	150	4		
HRMDS09-4032-4TL150		40	32	50	150	4		

E90ZC10

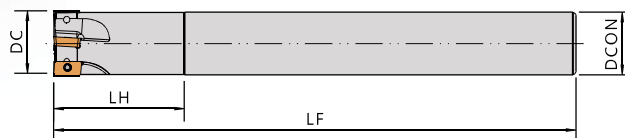
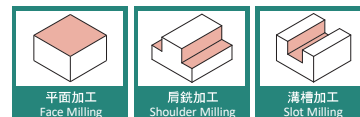

▼Recommended Inserts 建議刀片品牌：DIJET

Order No.	Insert	Dimensions(mm)					Screw	Wrench
		刀徑	長度	頭長	柄徑	刃數		
Right / Left		DC	LF	LH	DCON	I No.		
E90ZC10-1616M2	ZCMT100308R	16	150	25	16	2	CS25062S	DT-8
E90ZC10-1616R2		16	200	25	16	2		
E90ZC10-1616S2		16	250	25	16	2		
E90ZC10-1816M2		18	150	25	16	2		
E90ZC10-1816R2		18	200	25	16	2		
E90ZC10-1816S2		18	250	25	16	2		
E90ZC10-2020M3		20	150	25	20	3		
E90ZC10-2020R3		20	200	25	20	3		
E90ZC10-2020S3		20	250	25	20	3		
E90ZC10-2525M4		25	150	32	25	4		
E90ZC10-2525R4		25	200	32	25	4		
E90ZC10-2525S4		25	250	32	25	4		

Long-neck Type 長頸型								
E90ZC10-1615M2-40	ZCMT100308R	16	150	40	15	2	CS25062S	DT-8
E90ZC10-1616M2-40		16	150	40	16	2		
E90ZC10-1716M2-40		17	150	40	16	2		
E90ZC10-2019Q3-50		20	180	50	19	3		
E90ZC10-2020Q3-50		20	180	50	20	3		
E90ZC10-2120Q3-50		21	180	50	20	3		
E90ZC10-2524R4-50		25	200	50	24	4		
E90ZC10-2525R4-50		25	200	50	25	4		
E90ZC10-2625R4-50		26	200	50	25	4		

MWG

球刀

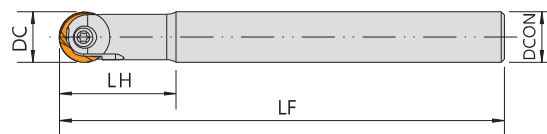
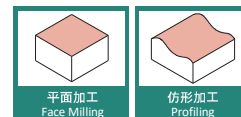

▼Recommended Inserts 建議刀片品牌：WALTER

Order No.	Insert	Dimensions(mm)				Screw	Wrench
		刀徑 DC	柄徑 DCON	長度 LF	頭長 LH		
MWG08-08A	P32..-D08	8	8	100	25	CSG308/FS397	DBIT-T8
MWG08-08AL				130	30		
MWG08-10A		8	10	110	25		
MWG08-10AL				140	55		
MWG10-10A	P32..-D10	10	10	110	30	CSG410/FS390	DBIT-T15
MWG10-10AL				150	65		
MWG12-12A	P32..-D12	12	12	130	32	CSG512/FS391	DBIT-T20
MWG12-12AL				180	75		
MWG16-16A	P32..-D16	16	16	140	36	CSG516/FS392	DBIT-T20
MWG16-16AL				180	75		
MWG20-20A	P32..-D20	20	20	150	45	CSG520/FS393	DBIT-T20
MWG20-20AL				180	75		
MWG25-25A	P32..-D25	25	25	160	45	CSG625/FS394	DBIT-T20
MWG25-25AL				200	85		
MWG30-32A	P32..-D30	30	32	180	56	CSG830/FS395	DBIT-T30
MWG30-32AL				230	110		
MWG32-32A	P32..-D32	32	32	180	56	CSG830/FS395	DBIT-T30
MWG32-32AL				230	110		

HML

高硬鋼刀桿

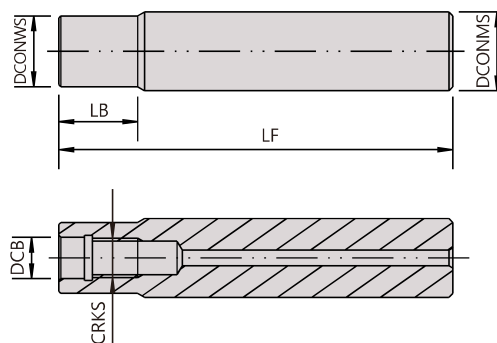

高硬鋼

Harden alloy steel screw-in holder

Standard with Coolant thru

Order No.	Dimensions(mm)					
Right / Left	機台夾持柄徑	長度	螺紋	連接孔徑	前端長度	刀具安裝直徑
	DCONMS	LF	CRKS	DCB	LB	DCONWS
HML10M05-120	10	120	M5	5.5	10	8
HML12M06-100	12	100	M6	6.5	12	10
HML12M06-150		150				
HML16M08-100	16	100	M8	8.5	16	14
HML16M08-150		150				
HML20M10-100	20	100	M10	10.5	20	18
HML20M10-150		150				
HML20M10-200		200				
HML25M12-100	25	100	M12	12.5	25	23
HML25M12-150		150				
HML25M12-200		200				
HML25M12-250		250				
HML32M16-150	32	150	M16	17	32	30
HML32M16-200		200				
HML32M16-250		250				
HML32M16-300		300				

HME

鎢鋼刀桿

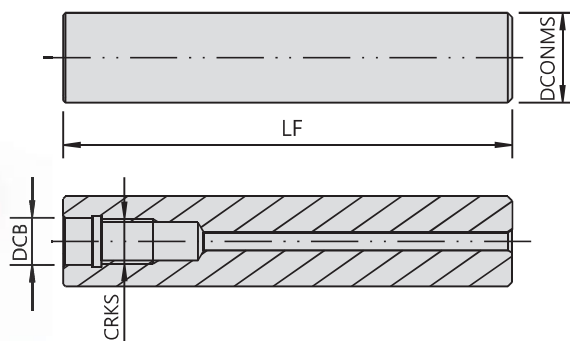

鎢鋼

Carbide screw-in holder

Standard with Coolant thru

Order No.	Dimensions(mm)			
Right / Left	機台夾持柄徑	長度	螺紋	連接孔徑
	DCONMS	LF	CRKS	DCB
HME08M04-100	8	100	M4	4.5
HME10M05-100	10	100	M5	5.5
HME10M05-150		150		
HME12M06-100	12	100	M6	6.5
HME12M06-150		150		
HME16M08-100	16	100	M8	8.5
HME16M08-150		150		
HME16M08-200		200		
HME16M08-250		250		
HME20M10-150	20	150	M10	10.5
HME20M10-200		200		
HME20M10-250		250		
HME25M12-150	25	150	M12	12.5
HME25M12-200		200		
HME25M12-250		250		
HME25M12-300		300		