

570-PWLN

95°

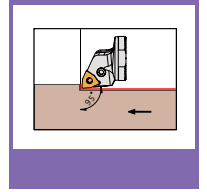
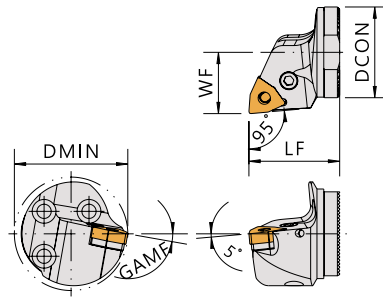

with coolant 有水孔

Order No.	Insert	Dimensions(mm)					Parts					Wrench
		柄徑	工作寬度	長度	最小加工徑	徑向前角						
Right / Left		DCON	WF	LF	DMIN	GAMF						
570-PWLN-40-08	WNMG0804	40	27	38	50	8°	SMW-423	CS-LSP4	CP-LL4	CS-LS4	LW030	

\*Dia:40mm(柄徑)→ Connection Screw(連接螺絲):CSH0620 / Center Pin(中心梢):WSD6-570 / Wrench(板手):LW050

570-STFP

91°

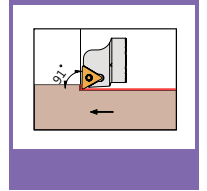
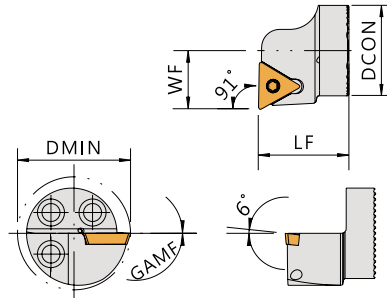
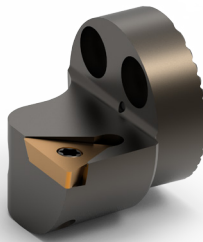

with coolant 有水孔

Order No.	Insert	Dimensions(mm)					Parts	Wrench
		柄徑	工作寬度	長度	最小加工徑	徑向前角		
Right / Left		DCON	WF	LF	DMIN	GAMF		
570-STFPR-16-11	TPMT1103	16	11	20	20	0°	CS25061S	FT-7
570-STFPR-20-11	TPMT1103	20	13	20	25	0°	CS25061S	FT-7

\*Dia:16mm(柄徑)→ Connection Screw(連接螺絲):CSH0308 / Center Pin(中心梢):WSD4-570 / Wrench(板手):LW025

\*Dia:20mm(柄徑)→ Connection Screw(連接螺絲):CSH3512 / Center Pin(中心梢):WSD6-570 / Wrench(板手):LW025

570-GNDIR

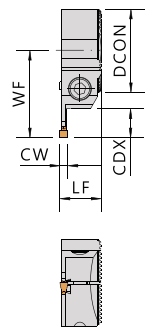
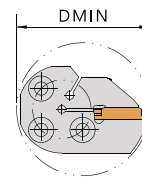
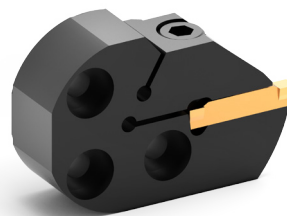
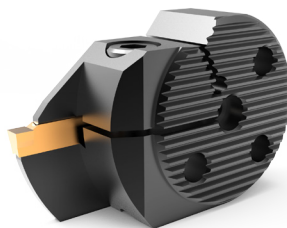

Order No.	Insert	Dimensions(mm)						Parts	Wrench
		柄徑	工作寬度	長度	最小加工徑	切寬	最大切深		
Right / Left		DCON	WF	LF	DMIN	CW	CDX		
570-GNDIR-32-T310	GCMN30	32	33	15.5	50	3	10	CSH0520	LW040

\*Dia:32mm(柄徑)→ Connection Screw(連接螺絲):CSH0516 / Center Pin(中心梢):WSD6-570 / Wrench(板手):LW040